



INSPIRING PROFILES

ORAC[®]
DECOR

'The making of'

INSPIRING PROFILES

ORAC[®]
DECOR

The script

NL

Welkom in de droomwereld van ORAC DECOR®.

ORAC DECOR® is dé referentie voor hoogkwalitatieve en architecturale profielen. Een complete collectie gemaakt door en voor gepassioneerde vaklui. Stielmannen met een innovatieve geest die houden van innovatieve en makkelijk te installeren kwaliteitsproducten. Van plinten en indirecte verlichtingsprofielen over multifunctionele profielen tot en met kroonlijsten met karakter. Eigentijdse kwaliteitsoplossingen, functioneel én decoratief. En op maat van elk project. Met ORAC DECOR® heeft u alle troeven in handen om uw project in uitstekende banen te leiden.

U bent de regisseur van uw eigen film of project. Wij bieden u al de mogelijke noodzakelijke accessoires/rekwisieten om van uw project een pronkstuk te maken.

Samen vormen we een ijzersterk team, klaar voor de eerste Oscar!

FR

Bienvenue dans le monde féérique d'ORAC DECOR®.

ORAC DECOR® est la référence en matière de profilés architecturaux haut de gamme. Une collection complète, faite par et pour des spécialistes passionnés. Des stylistes amoureux des produits novateurs et faciles à installer, proposent des plinthes, des profilés d'éclairage indirect, des profilés multifonctions, en passant par des corniches de grand caractère.

Des solutions modernes, de haute qualité, fonctionnelles, décoratives spécifiques à chaque projet : Avec ORAC DECOR®, vous avez tous les atouts en main pour mettre votre projet sur les rails.

Vous êtes le réalisateur de votre propre film ou projet. Nous vous fournissons tous les accessoires et outils pour en faire une perle parmi les perles.

Ensemble, nous formons une équipe solide comme un roc, prête pour son premier Oscar!

EN

Welcome to the dream world of ORAC DECOR®.

ORAC DECOR® sets the standard for high quality architectural mouldings. Our complete collection is made by and for passionate professionals, craftsmen with logical minds who appreciate high quality products that are innovative and easy to install. From skirting boards and indirect lighting profiles to multifunctional profiles and cornices with character, our high quality contemporary solutions are functional, decorative and tailored to each project. With ORAC DECOR®, you have nothing but trumps in your hand to bring your project to an outstanding conclusion.

You are the director of your own film or project. We can offer you every possible accessory or prop that you need to turn your project into a showpiece.

Together, we make an unbeatable team, ready for the first Oscar!

DE

Willkommen in der Traumwelt von ORAC DECOR®.

ORAC DECOR® ist der führende Anbieter von hochqualitativen Zierprofilen. Eine umfassende Kollektion - hergestellt von passionierten Fachleuten für passionierte Fachleute. Kenner mit logischem Sachverstand, die innovative und mühelos installierbare Qualitätsprodukte schätzen. Von Sockelleisten und Lichtleisten für indirekte Beleuchtung über multifunktionale Leisten bis hin zu stilvollen Eckleisten. Zeitgemäße Qualitätslösungen, funktionell und dekorativ. Und individuell abgestimmt auf jedes Projekt. Mit ORAC DECOR® haben Sie alle Trümpfe in der Hand, die den Erfolg Ihres Projekts gewährleisten.

Sie sind der Regisseur Ihres eigenen Films oder Projekts. Wir bieten Ihnen alle erdenklichen und benötigten Accessoires, damit Ihr Projekt ein Meisterwerk wird.

Gemeinsam sind wir ein bärenstarkes Team - bereit für den ersten Oscar!

ES

Bienvenido al mundo elegante de ORAC DECOR®.

ORAC DECOR® es un referente en el mundo de los perfiles arquitectónicos orientados a la decoración. Toda una gama realizada por y para ayudar a crear valor añadido en los proyectos; tanto de casas particulares, como restaurantes, hoteles, etc. Resaltar la innovación, calidad y fácil instalación de nuestros productos; desde zócalos, molduras, cornisas, marcos de puertas, perfiles con iluminación indirecta y la novedad de nuevos modelos multifuncionales y todo ello resistente al agua, con posibilidad de instalarse en el exterior y listas para ser pintadas. Proponemos soluciones actuales, de calidad, funcionales y decorativas. Con ORAC DECOR® puedes crear tu mundo según tus gustos y necesidades con total garantía de éxito.

Puedes ser el decorador de su propia película en tu mundo. Nosotros ponemos a tu disposición todos los accesorios/utilería necesarios para que el resultado final cumpla con tus expectativas. Juntos formamos un buen equipo y podemos conseguir el primer 'Oscar'.





PUROTOUCH®

- Een kwalitatieve polyurethaan van hoge densiteit
- Un polyuréthane moulé de haute densité
- A moulded quality high-density polyurethane
- Ein hochwertiges, hochdichtes Polyurethanschaum
- Poliuretano de alta calidad y de elevada densidad

DUROPOLYMER®

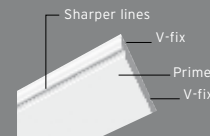
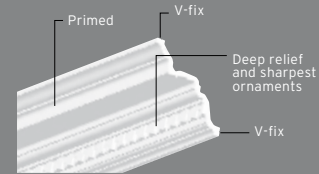

ref. Luxus **LXX**

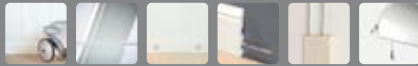
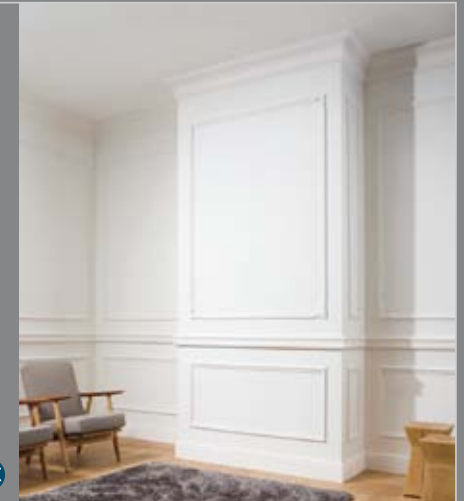

DUROPOLYMER®

- Geëxtrudeerde en impactbestendige polystyreenmix van hoge densiteit
- Un polymère extrudé résistant aux impacts à base d'un mélange de polystyrènes haute densité
- An extruded and impact-resistant polymer based on a high-density polystyrene
- Extrudierter und schlagbeständiger, hochdichter Polystyrolmix
- Polímero fabricado por extrusión, resistente a impactos fuertes a base de una mezcla de poliestireno de alta densidad

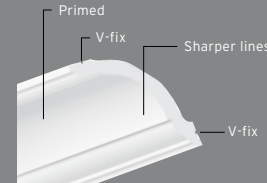

ref. Axxent **AXX**



DUROFOAM®

- Geëxtrudeerde lichtgewichtpolymeer op basis van een polystyreenmix van medium densiteit
- Un polymère léger extrudé à base d'un mélange de polystyrènes de densité moyenne
- An extruded lightweight polymer based on a medium-density polystyrene blend
- Extrudiertes leichtes Polymer auf der Grundlage einer Polystyrolmischungmittlerer Dichte
- Polímero extrusionado de peso ligero a base de una mezcla de poliestireno de densidad media

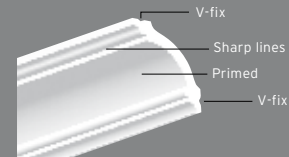

ref. Basixx **BXX**



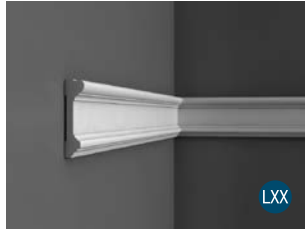

DX121-2300

P72



PX103

P66



PX120

P66



PX114

P66



SX156

P69

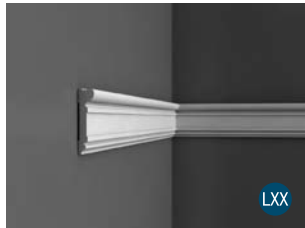

DX119-2300

P72

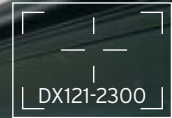

DX121-2300



PX103

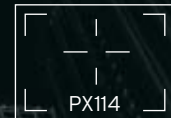

PX114

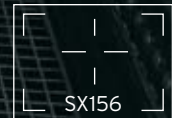

SX156

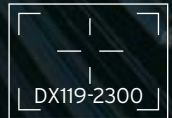

DX119-2300

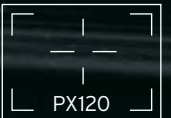

PX120



SX118F

P69



D62

P89



PX117

P66



PX113

P50



SX118

SX104

also starring in this collection ★



SX118

P69



PX103

P66

Metiendo Vivendum - Louvain



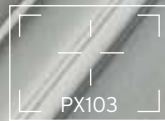
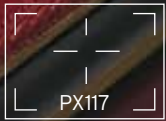

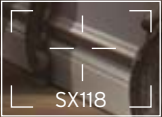
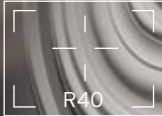

R40

P86

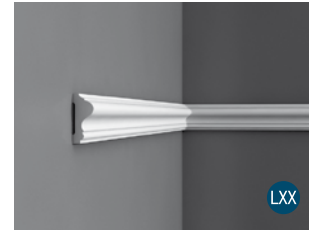

P8020/P8020F

P60

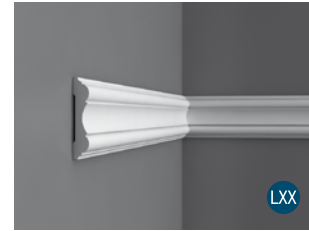

P8040

P62



SX118

P69

Bucharest

*Sofitel
Brussels*



C322

P43



C332

P45



C333

P45



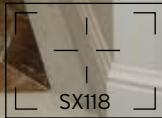
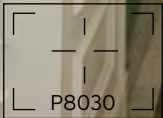
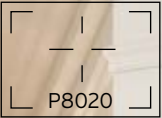
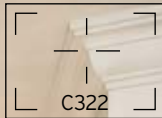

C322

LXX

P43



R38

LXX

P89



P8020

LXX

P60

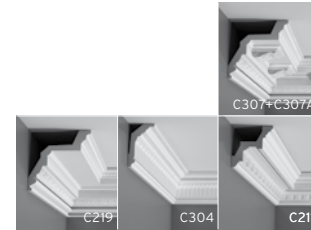

also starring in this collection ★



C422

LXX

P50

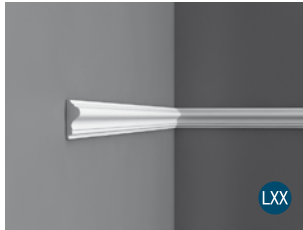

P8030

LXX

P60



also starring in this collection ★

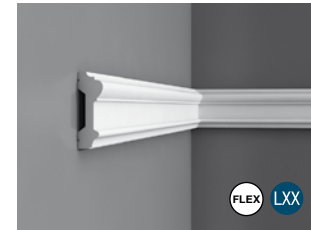

P9010/P9010F

FLEX LXX

P61

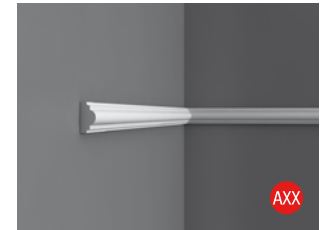

PX120

AXX

P66



SX118

LXX

P69



also starring in this collection ★



SX156

LXX

P69



PX103

AXX

P66

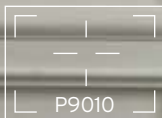
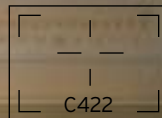
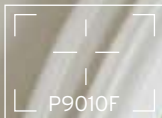





C217

LXX

P45



C321

★ also starring in this collection



C332

LXX

P45

★ also starring in this collection
designed by Jaques Vergracht

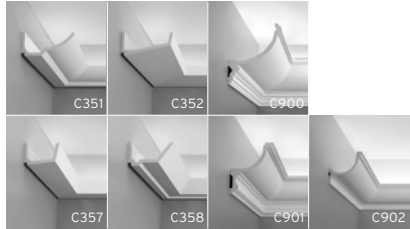

C351

C352

C900

C357

C358

C901

C902



C364

C363

C362

also starring in this collection ★
designed by Pierre Daems



C361

LXX

P58/101



DX157-2300

AXX

P67/68

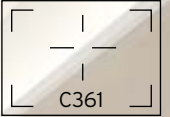

C361



DX157-2300

Lobby Amsterdam



St-Petersburg

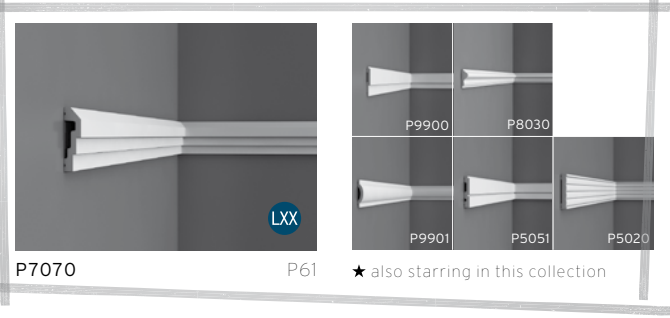
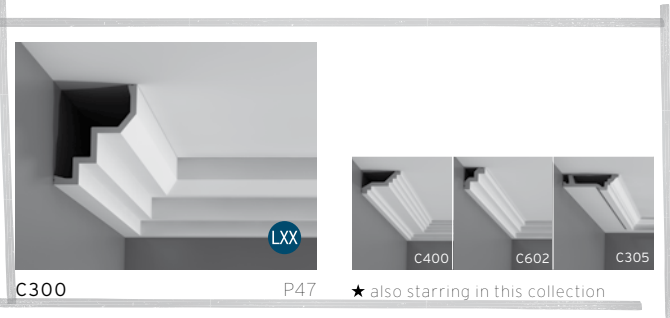
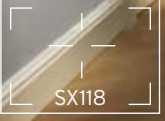

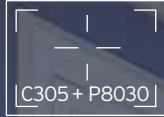
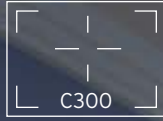

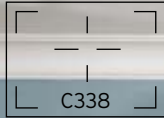
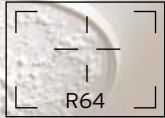

Take 1, lisbon



C338

P47



★ also starring in this collection



R64

P89



also starring in this collection ★



C336

P48



also starring in this collection ★

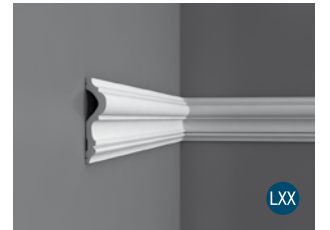

P8050

P62



also starring in this collection ★



SX156

P69



C336

R64

C338

P8050

SX156

ORAC
DECOR

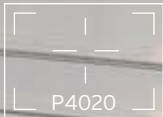



C990

LXX

P46

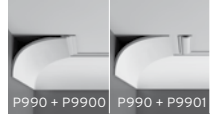

P990 + P9900 P990 + P9901

★ also starring in this collection
designed by Xavier Donck



C335

also starring in this collection ★



C219

LXX

P50



P9010

LXX

P61



P8050

also starring in this collection ★

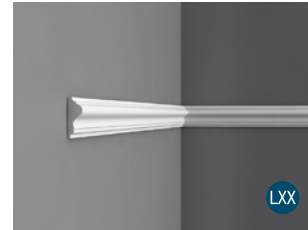

P8030

LXX

P60

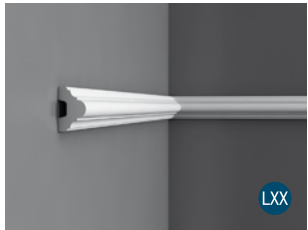

P4020

LXX

P60



PX103

AXX

P66



SX118

LXX

P69



SX104

★ also starring in this collection



SX156

also starring in this collection ★



SX155

LXX

P69



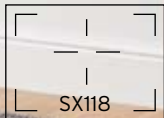
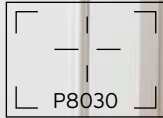
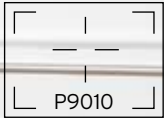

C217

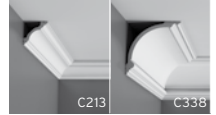

LXX

P45

★ also starring in this collection



P8030D

LXX

P62



P9010

LXX

P61

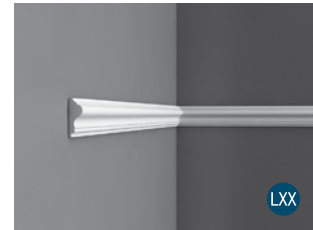

P8030

LXX

P60





C307+C307A

P50

London
Notting Hill



SX118

P69



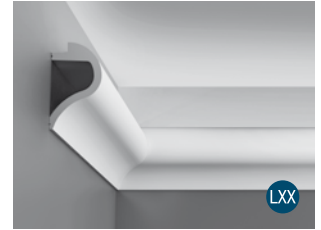
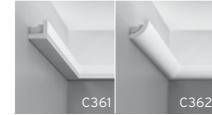
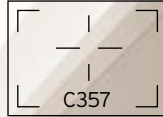

also starring in this collection ★
designed by Pierre Daems

C364

P58/101



also starring in this collection ★

DX163-2300

P67/69



C357

P58/P101



★ also starring in this collection
designed by Jaques Vergracht

*Indirect lighting
Paris* →

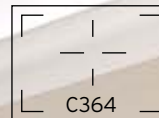

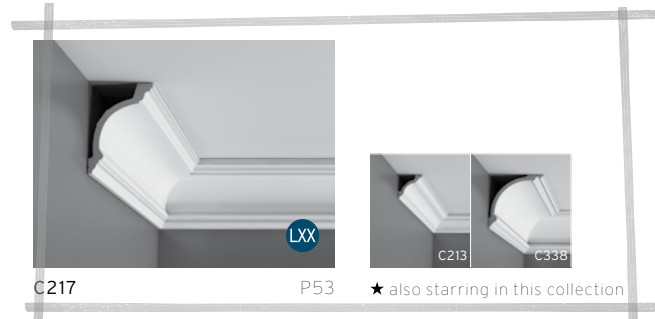

*Dressing Lady...
Cambridge*



SX118

P66



★ also starring in this collection



also starring in this collection ★



CX106

P53



H101

P81

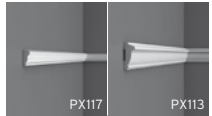

also starring in this collection ★



PX103/PX103A

P66

- PX113 P66
- PX103 P66
- SX118 P69



AXX

AXX

LXX

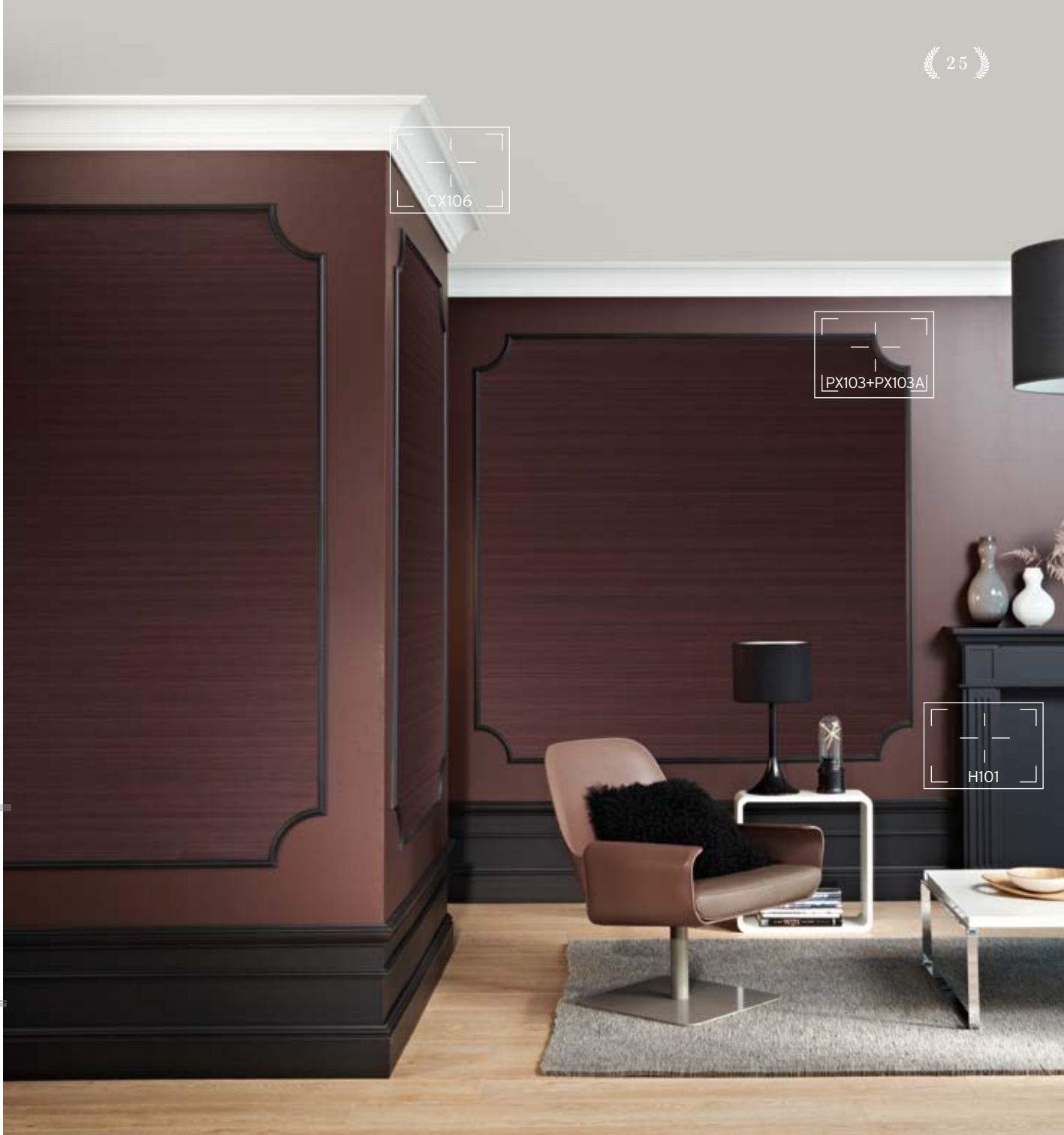
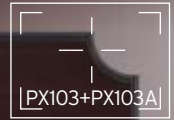

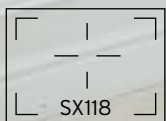
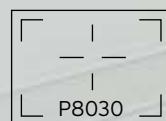
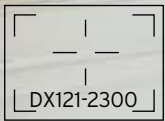
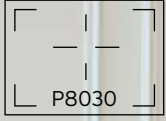
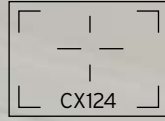

Chateau Mont-Royal
Chantilly



CX124

P52

AXX



★ also starring in this collection



P8030

P60

LXX

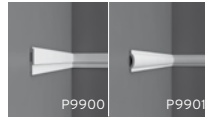

★ also starring in this collection



C322

P45

LXX



DX121-2300

P72

LXX

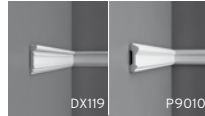

★ also starring in this collection



R08

P86

LXX



SX118

P69

LXX



★ also starring in this collection

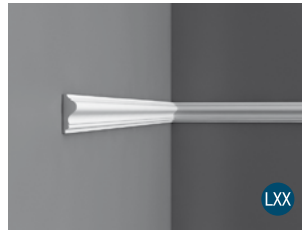

P8030/8030F

P60

LXX



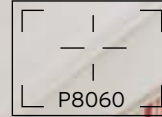
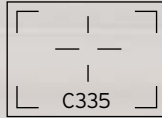



C335

P47



C337

P47

Majestic Barcelona

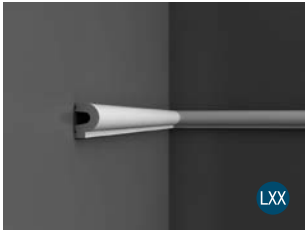

P8060

P60





CX107

PX103

CX107

PX103

SX118



CX107

P53

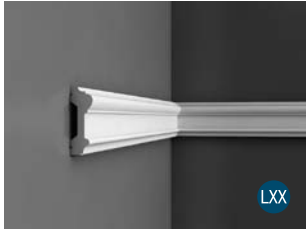

P9010

P61



PX103

P66

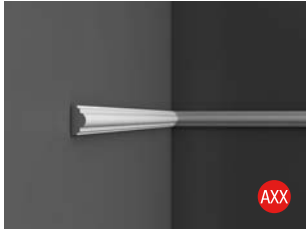

PX120

P66



CX107

P53



PX103

P66



SX118

P69



SX156

P69

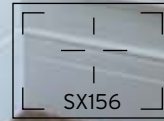
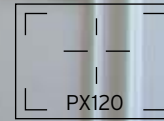
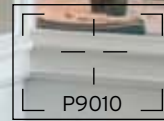



PX103



PX120



PX120

P66



PX103

P66



Lounge
Boca Grande

*Boca Grande
Barcelona*

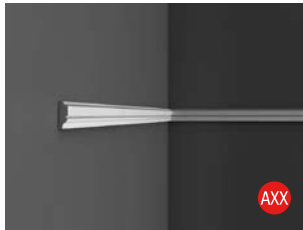

PX116

P66



PX144

P66

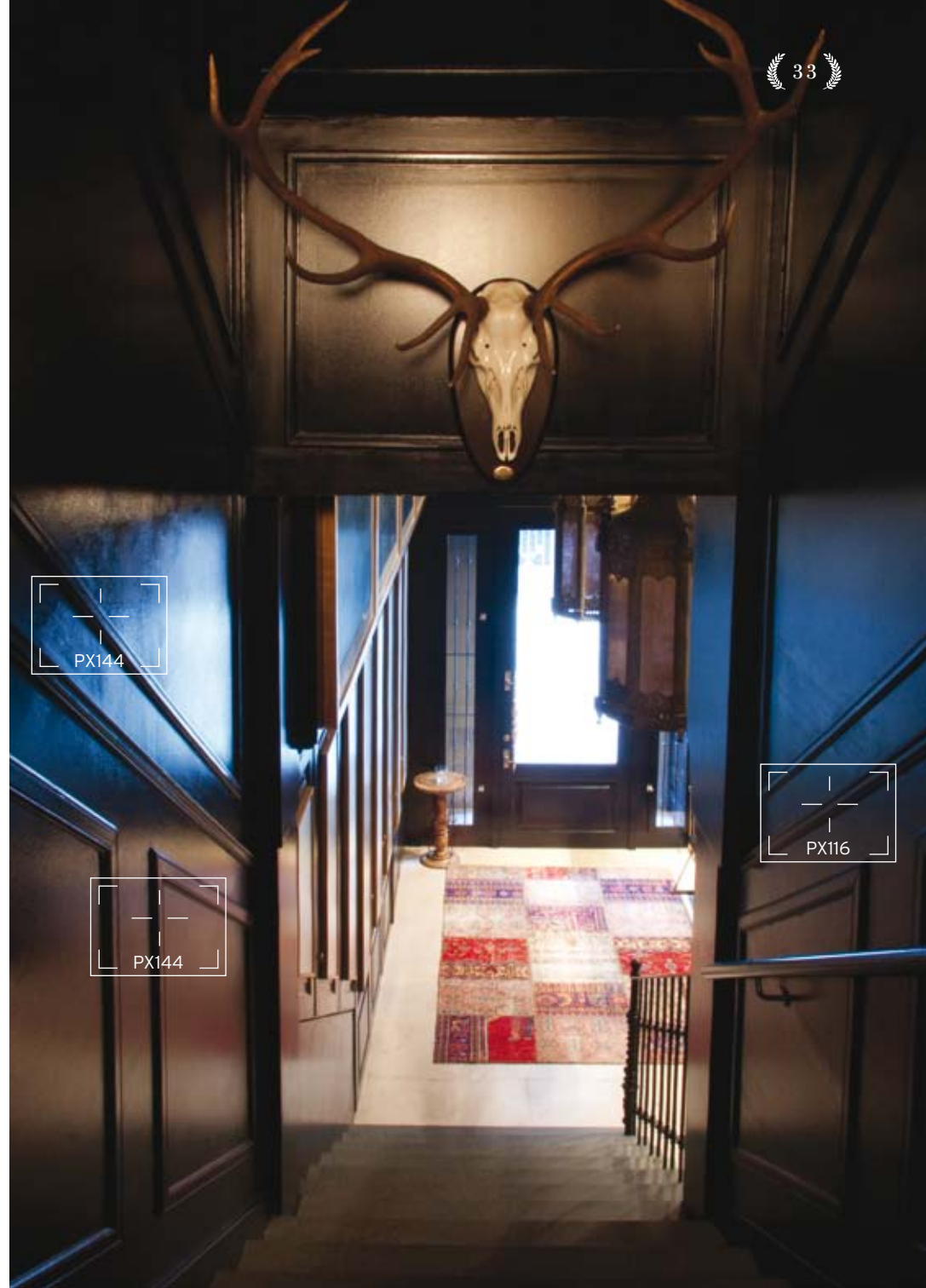

PX144

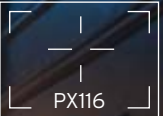

PX116

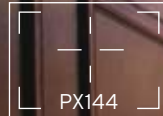

PX144

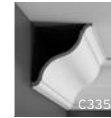

also starring in this collection ★



C334

LXX

P47

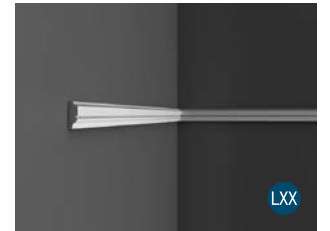

P9901

LXX

P47/60



also starring in this collection ★



SX156

LXX

P69



C334

P9901

SX156

ORAC
DECOR
SCENE 02
PARIS

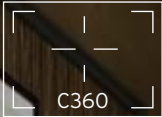
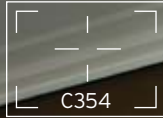

C354



P42

★ also starring in this collection

← Hamburg



C360

P42

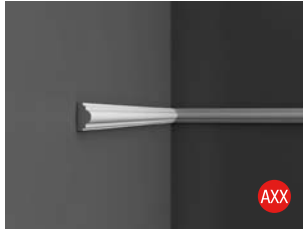

PX120

P66



C901

P45

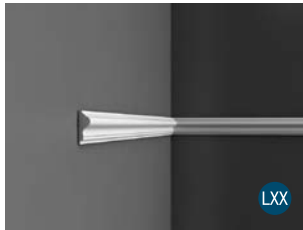

P8030

P60



SX118

P69

Hotel Alma Barcelona





LUXXUS

COLLECTION



NL

Binnen het overkoepelende merk ORAC DECOR® neemt Luxxus een exclusieve plaats in. Het gamma omvat dan ook een uniek aanbod van luxe creatieve profielen en decoratieve accessoires. Een compleet gamma voor een totaalconcept in stijl: van kroon- en wandlijsten over plinten en lambrisering tot verlichtingssystemen en deurdecoratie, telkens met dat tikkeltje meer.

De verschillende moulures vinden elkaar in een sterk visuele impact. Zo bepalen ze mee de sfeer binnenshuis met hun opvallende look, hun reliëf of hun opmerkelijke grootte. Kortom, ideaal om een interieur een niet-alledaagse finishing touch te geven. De volledige lijn wordt bovendien continu aangevuld met vernieuwende ideeën en creaties van topdesigners.

Niet alleen een buitengewoon design maar ook een onberispelijke kwaliteit kenmerkt Luxxus. De moulures zijn vervaardigd van kwalitatieve kunststoffen als Purotouch® (hoogwaardig polyurethaan) en Duropolymer® (een polymeer met hoge dichtheid). Materialen die hun kwaliteit ruimschoots bewezen hebben én die een vlotte plaatsing toelaten.

FR

Occupant une place exclusive dans la marque ORAC DECOR®, la gamme Luxxus comprend un choix inouï de profilés créatifs et d'accessoires décoratifs de luxe: moulures de plafond et murales, plinthes, lambris, décorations de portes et systèmes d'éclairage... Bref, une gamme complète

pour un concept total esthétique, qui se distingue par son style. Combinées, les différentes moulures ont un impact visuel puissant et élégant. Originales, travaillées ou monumentales, elles contribuent à définir l'atmosphère de votre intérieur, à lui donner l'accent qui fera sa finition magistrale. La gamme étendue est complétée en permanence par des idées et créations innovantes de concepteurs de pointe.

La gamme Luxxus se distingue par son design exceptionnel et sa qualité irréprochable. Les moulures sont fabriquées dans des matières synthétiques de qualité supérieure, telles que le Purotouch® (un polyuréthane haut de gamme) et le Duropolymer® (un polymère haute densité). Des matériaux dont la qualité dont la qualité prouvée permet une installation rapide.

EN

Luxxus occupies an exclusive position within the overall ORAC DECOR® brand, as it contains a unique selection of luxury creative profiles and decorative accessories. A complete range to provide a total concept with real style - from cornices and panel mouldings, skirting-boards and wainscoting to lighting systems and door furniture, all with that little extra something.

The different mouldings are united in their strong visual impact, which means they help set the tone of your interior with their striking looks and contours or their conspicuous dimensions. In short, the ideal way to put that out-of-the-ordinary finishing touch to your decor. And what is more, we are continually adding innovative ideas and creations from top designers.

It's not just its remarkable design but also its impeccable quality that makes Luxxus so special. The mouldings are made from top quality plastics such as Purotouch® (high-grade polyurethane) and Duropolymer® (a high-density polymer) - materials of well-proven quality that also allow easy fitting.

DE

Innerhalb der übergeordneten Marke ORAC DECOR® nimmt Luxxus einen exklusiven Platz ein. Das Programm enthält ein einzigartiges Angebot luxuriöser kreativer Profile und dekorativer Zubehörteile. Ein komplettes Programm für ein stilvolles Gesamtkonzept: von Eck- und Wandleisten über Sockelleisten bis hin zu Beleuchtungssystemen und Türdekorationen, jeweils mit dem gewissen Etwas.

Die verschiedenen Zierleisten haben alle eine stark visuelle Wirkung. Sie bestimmen die Atmosphäre im Haus mit ihrem auffallenden Look, ihrem Relief oder ihrer bemerkenswerten Größe. Kurzum, ideal, um einem Interieur einen nicht alltäglichen Finishing Touch zu geben. Die vollständige Reihe wird darüber hinaus kontinuierlich um erneuernde Ideen und Kreationen von Spitzendesignern ergänzt.

Nicht nur ein außergewöhnliches Design, sondern auch eine makellose Qualität kennzeichnet Luxxus. Die Zierleisten werden aus Qualitätskunststoffen wie Purotouch® (hochwertiges Polyurethan) und Duropolymer® (ein Polymer mit hoher Dichte) hergestellt. Dieses Material hat seine Qualität bewiesen und erlaubt eine reibungslose Anbringung.

ES

La máxima aspiración de ORAC DECOR® es seguir sorprendiéndole cada año con productos que destaquen, tanto en calidad como en innovación y tecnología. Los 40 años de experiencia nos colocan en una situación privilegiada y, podemos afirmar que la marca ORAC DECOR® se ha convertido en una marca europea que marca tendencia en el mundo de los perfiles arquitectónicos para la decoración, tanto para el interior, como para el exterior.

Todo el equipo de ORAC DECOR® se centra en la búsqueda constante de nuevas ideas, tecnologías y diseños con el objetivo de aportar a nuestros clientes las opciones necesarias para los diferentes estilos de decoración, así como múltiples soluciones prácticas en las instalaciones. Procuramos siempre adaptar la comodidad a la sencillez del uso, la calidad a la fiabilidad y lo tradicional a lo innovador.

Los retos del futuro nos obligan a una completa orientación al mercado, escuchando constantemente las propuestas y sugerimientos que nos hacen nuestros clientes, tanto arquitectos, interioristas, decoradores, profesionales aplicadores o consumidores finales.

En ORAC DECOR® intentamos mantener un constante estado de renovación, tanto en diseños como en soluciones creativas, así como en aplicar las tecnologías más ingeniosas, desarrolladas por nuestros ingenieros. En este sentido, desde los años 70 nuestra línea Luxxus nos ofrece como primera marca la esencia de los perfiles arquitectónicos más elegantes y señoriales.



AXXENT

COLLECTION

NL

Axxent, een collectie van ORAC DECOR®, is een kwaliteitsvol assortiment oplossingslijsten. Een totaalgamma dat de vakman helpt om kwaliteitswerk te leveren tegen een betaalbare prijs. Een assortiment van kroon- en wandlijsten, plinten, deuromlijstingen en multifunctionele lijsten. Ontdek nu een wereld van mogelijkheden en oplossingen met Axxent.

Alle Axxent producten bestaan uit Duropolymer®, een geëxtrudeerde, stoot- en waterbestendige polymereermix van hoge dichtheid. Hét ideale materiaal voor plinten en deuromlijstingen. Bovendien is Duropolymer® 100% recycleerbaar.

FR

Axxent, une collection d'ORAC DECOR®, est un choix de moulures universelles de qualité. Une gamme complète pour fournir un travail de qualité à un prix abordable. Un choix de corniches, de cimaises, de plinthes, d'encadrements de porte et de moulures multifonctionnelles. Découvrez aujourd'hui un univers plein de possibilités et de solutions avec Axxent.

Tous les produits Axxent sont réalisés en Duropolymer®, un mélange de polymères extrudés de haute densité, résistant aux chocs et à l'eau. Le matériau idéal pour les plinthes et les encadrements de porte. En plus: Duropolymer® est 100% recyclable.

EN

Axxent, a collection by ORAC DECOR®, is a high-quality, solution-oriented range of mouldings. This complete range helps skilled decorators to deliver first-rate work at an affordable price. It includes cornice and panel mouldings, door frames and multifunctional profiles. Discover a world of possibilities and solutions with Axxent.

All Axxent products are made from Duropolymer®, an extruded, impact and water resistant high-density polymer blend. It's the perfect material for skirting and door frames. Another important advantage: Duropolymer® is 100% recyclable.

DE

Axxent, eine Kollektion aus Orac Decor®, ist ein qualitativ hochwertiges Sortiment von Zierleisten. Eine Kollektion, mit der der Fachmann Qualitätsarbeit preiswert anbieten kann. Ein Sortiment aus Eck- und Wandleisten, Sockelleisten, Türumrandungen und multifunktionalen Profilen. Entdecken Sie eine Welt der zahllosen Möglichkeiten und funktionellen Lösungen mit Axxent.

Alle Axxent Produkte bestehen aus Duropolymer®, einer extrudierten, stoß- und wasserfesten Polymermischung mit hoher Dichte. Das ideale Material für Sockelleisten und Türumrandungen. Ein weiterer Vorteil: Duropolymer® ist 100 % recycelbar.

ES

Axxent, una de las colecciones de ORAC DECOR®, es una gama de alta calidad, pensada para ofrecer soluciones. Esta gama ayuda a decoradores e interioristas a ofrecer valor añadido en sus proyectos a un precio accesible. Incluye cornisas, molduras, marcos para puerta y perfiles multifuncionales. Descubra Orac Axxent.

La línea Axxent utiliza la tecnología llamada Duropolymer®, una mezcla extruida de polímero de alta densidad, resistente al agua y a los golpes. Es el material perfecto para zócalos y marcos para puerta. Otra ventaja importante: Duropolymer® es 100% reciclable.

BASIXX

COLLECTION

NL

Met de Basixx collectie spreekt ORAC DECOR® sinds zijn lancering een jong en trendy publiek aan. Dankzij de introductie van 5 nieuwe modellen wordt de collectie nu écht compleet. Een inventieve, originele en budgetvriendelijke collectie die op een tijdloze manier elk interieur afwerkt. Deze sierlijsten weten wand en plafond elegant te verbinden zodat het spel van licht en schaduw kan losbarsten.

ORAC DECOR® koos ervoor om zijn klanten een eenvoudig concept aan te bieden en ontwikkelde hiervoor families met telkens verschillende kroonlijsten per type huis. Zo kan voor elke leefruimte in één en hetzelfde huis een lijst uit dezelfde familie gebruikt worden.

Alle Basixx producten bestaan uit Durofoam®, een geëxtrudeerde lichtgewicht polymermix op basis van hoogkwalitatieve middendensiteitspolystyreen. Bovendien is Durofoam® 100% recycleerbaar.

FR

Avec la collection Basixx, ORAC DECOR® s'adresse depuis son lancement à un public jeune et branché. Et les cinq nouveaux modèles introduits complètent vraiment la collection. Une collection inventive, originale et à faible coût pour une finition intemporelle de n'importe quel intérieur. Ces moulures décoratives assurent une parfaite jonction mur /plafond qui laisse éclater le jeu d'ombres et de lumières.

ORAC DECOR® a choisi de proposer à ses clients un concept simple, et a développé

pour ce faire des familles de plusieurs corniches chacune par type de maison. Le client peut ainsi utiliser différentes corniches d'une même famille pour les différents espaces de vie de sa maison. Tous les produits Basixx sont réalisés en Durofoam®, un mélange de polymères extrudés de densité moyenne. En plus: Durofoam® est 100% recyclable.

EN

Since its launch, the Basixx collection by ORAC DECOR® has been addressing a young and trendy clientele. Thanks to the introduction of five new models the range is now really complete. An inventive, original and budget-friendly collection that completes each interior in a timeless way. These ornamental frames connect wall and ceiling elegantly so the play of light and shadow can burst out. ORAC DECOR® chose to offer its customers a simple concept for which it developed different families, each with different cornices per style. This way, products from the same family can be used for each room in the house.

All Axxent products are made from Durofoam®, an extruded lightweight polymer based on a medium-density polymer blend. Another important advantage: Durofoam® is 100% recyclable.

DE

Mit der Basixx-Kollektion spricht ORAC DECOR® seit deren Markteinführung ein junges und modeorientiertes Publikum an. Jetzt wurde die Kollektion mit fünf neuen Modellen abgerundet. Eine einfallsreiche, originelle, preiswerte Kollektion, die auf zeitlose Weise jeden Innenraum verschönert. Diese Zierleisten wissen Wand und Decke elegant zu verbinden, sodass das Spiel von Licht und Schatten freien Lauf nehmen kann. ORAC DECOR® beschloss, seinen Kunden ein einfaches Konzept zu bieten und entwickelte dafür gesonderte Stilfamilien mit jeweils verschiedenen Eckleisten pro Familie. So können in einem Haus verschiedene Eckleisten aus derselben Familie verwendet werden um einen einheitlichen Stil zu generieren.

Alle Basixx Produkte bestehen aus Durofoam®, einer extrudierten leichten Polymer auf der Grundlage einer Polymermischung mittlerer Dichte. Ein weiterer Vorteil: Durofoam® ist 100 % recycelbar.

ES

Desde su lanzamiento, ORAC DECOR® ha orientado la colección Basixx a un público joven y moderno. Ahora, gracias a la introducción de 5 nuevos modelos, la oferta queda completada. Una colección ingeniosa, original y asequible, que aporta un acabado atemporal a cualquier interior. Estas cornisas unen con elegancia la pared y el techo dejando estallar un juego de luces y sombras. ORAC DECOR® ha optado por ofrecer a

sus clientes un concepto sencillo; para ello hemos agrupado las referencias en familias, una para cada tipo de hogar; de esta forma se puede personalizar con un modelo diferente pero con el mismo estilo de decoración.

La línea Basixx utiliza la tecnología llamada Durofoam®, una mezcla extruida de polímero. Otra ventaja importante: Durofoam® es 100% reciclable.





C360

PUROTOUCH®
200 x 2 x 6 cm

LXX



C356

PUROTOUCH®
200 x 2 x 10 cm

LXX

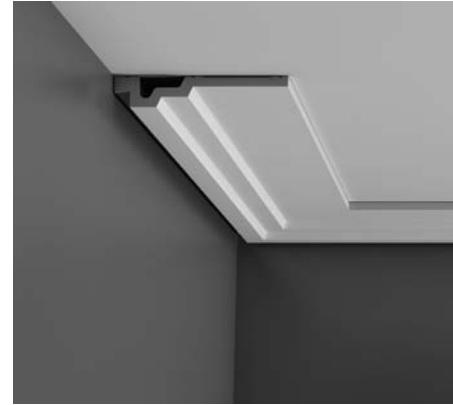

C353

PUROTOUCH®
200 x 3 x 16,5 cm

LXX



C355

PUROTOUCH®
200 x 3,5 x 11 cm

LXX



C354

PUROTOUCH®
200 x 4 x 21,5 cm

LXX



C250/C250F

PUROTOUCH®
200 x 1,5 x 1,5 cm

LXX FLEX $\nabla = 2,1$



C230/C230F

PUROTOUCH®
200 x 3 x 3 cm

LXX FLEX $\nabla = 4,2$



C260/C260F

PUROTOUCH®
200 x 4 x 5 cm

LXX FLEX $\nabla = 6,4$



C305



C305 + C212

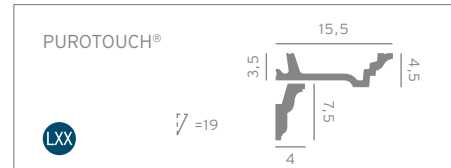

C305 + C213

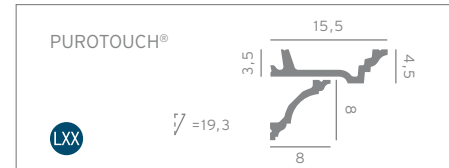

C305 + C321

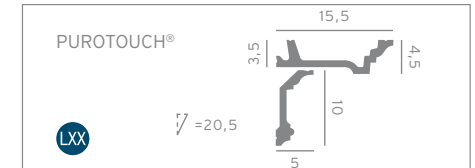

C305 + C211

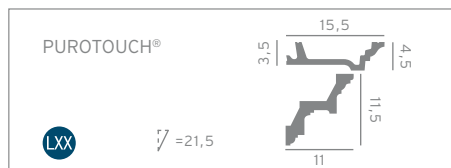

C215/C215F



C322/C322F

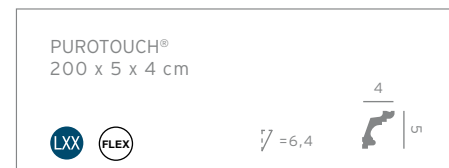

C602/C602F

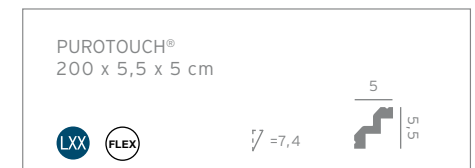



C400

PUROTOUCH®
200 x 6 x 10 cm

LXX

∠ = 11,7



C331/C331F

PUROTOUCH®
200 x 6 x 13,5 cm

LXX FLEX

∠ = 14,8



C200/C200F

PUROTOUCH®
200 x 6,5 x 5,5 cm

LXX FLEX

∠ = 8,4



C220/C220F

PUROTOUCH®
200 x 7,5 x 11,5 cm

LXX FLEX

∠ = 13,7



C213/C213F

PUROTOUCH®
200 x 8 x 8 cm

LXX FLEX

∠ = 11,3



C240/C240F

PUROTOUCH®
200 x 8 x 8 cm

LXX FLEX

∠ = 11,3



C321/C321F

PUROTOUCH®
200 x 10 x 5 cm

LXX FLEX

∠ = 11,2



C902/C902F

PUROTOUCH®
200 x 10 x 10 cm

LXX FLEX

∠ = 14,1



C217/C217F

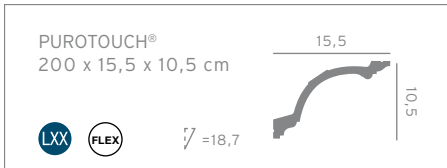

C332



C333/C333F

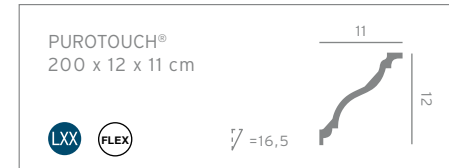

C339/C339F

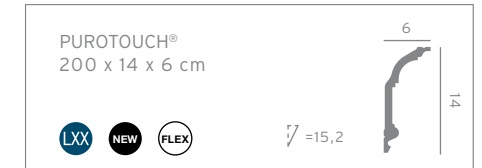

C334/C334F

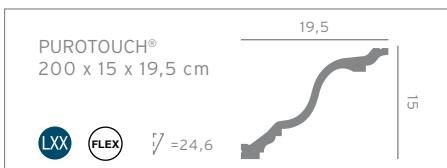

C901/C901F



C217/C217F

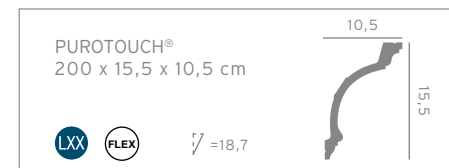

C900

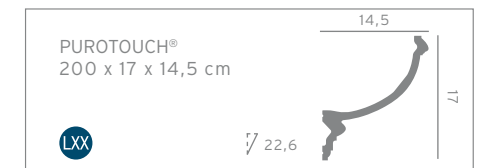



C990 - Designed by Xavier Donck

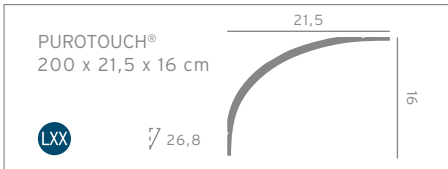

C990 + P9900 - Designed by Xavier Donck

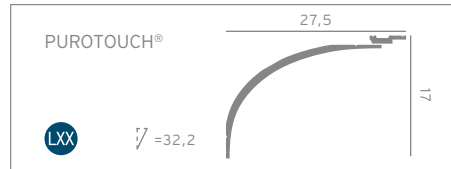

C990 + 2x P9900 - Designed by Xavier Donck

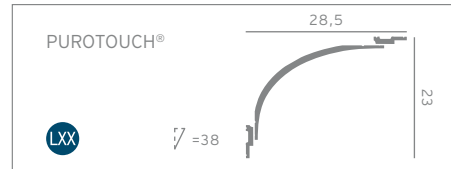

C990 + P9900 - Designed by Xavier Donck

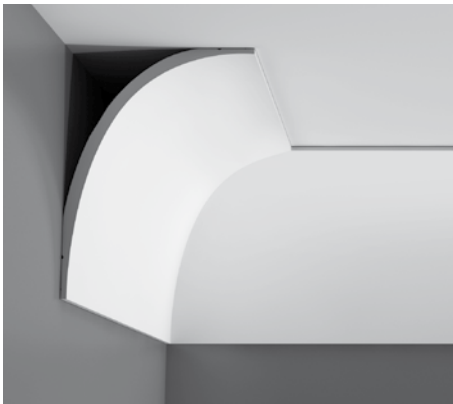
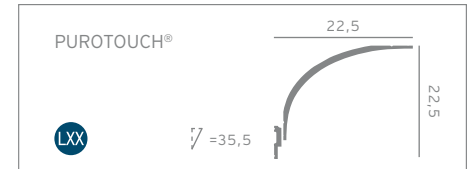

C990 - Designed by Xavier Donck

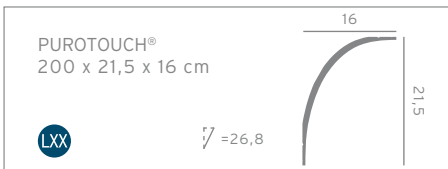

C990 + P9900 - Designed by Xavier Donck

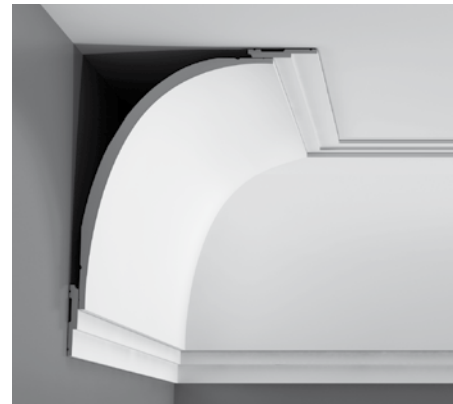
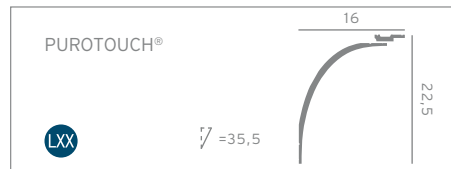

C990 + 2x P9900 - Designed by Xavier Donck

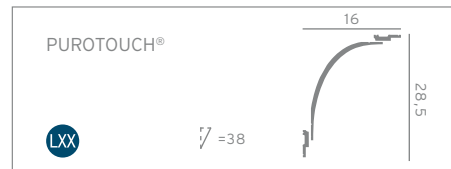

C990 + P9900 - Designed by Xavier Donck

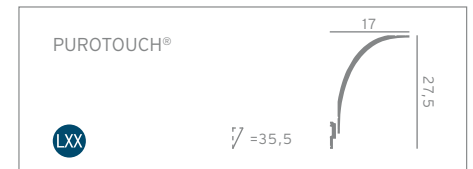



C990 + P9901 - Designed by Xavier Donck

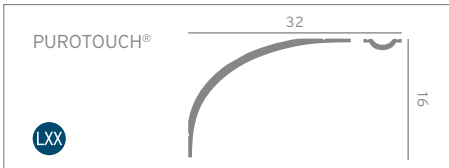

C337

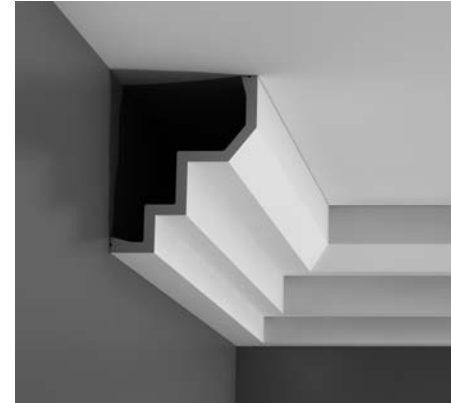
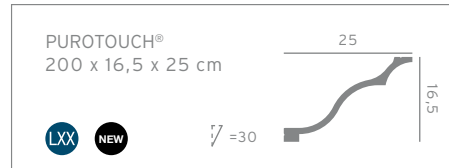

C300

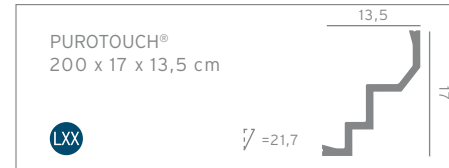

C338



C990 + P9901 - Designed by Xavier Donck



C335 - Designed by Xavier Donck

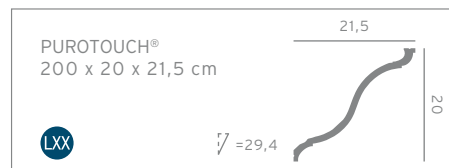

C335 - Designed by Xavier Donck

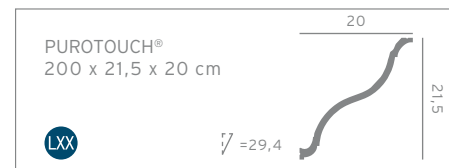

C335 + P9901 - Designed by Xavier Donck

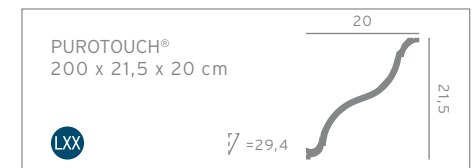



C332

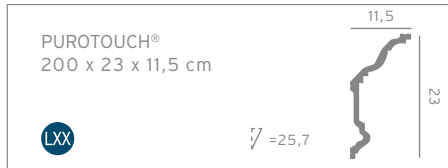

C337

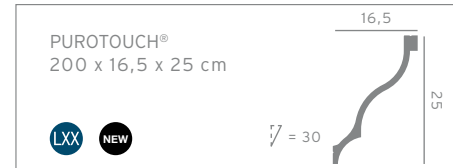

C340

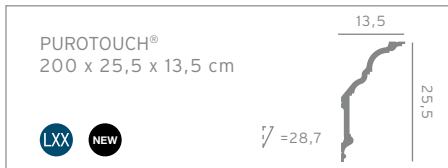

C336

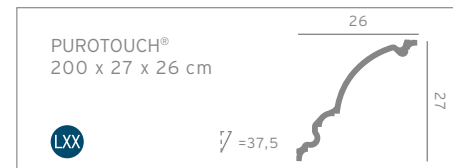



C214/C214F

PUROTOUCH®
200 x 6,5 x 3 cm

LXX FLEX

$\nabla = 7,2$



C212/C212F

PUROTOUCH®
200 x 7,5 x 4 cm

LXX FLEX

$\nabla = 8,5$



C402/C402F

PUROTOUCH®
200 x 9,5 x 10,5 cm

LXX FLEX

$\nabla = 14,4$



C216/C216F

PUROTOUCH®
200 x 11,5 x 13,5 cm

LXX FLEX

$\nabla = 17,7$



C201/C201F

PUROTOUCH®
200 x 11,5 x 5 cm

LXX FLEX

$\nabla = 12,5$



C211/C211F

PUROTOUCH®
200 x 11,5 x 11 cm

LXX FLEX

$\nabla = 15,9$



C304/C304F

PUROTOUCH®
200 x 12 x 7 cm

LXX FLEX

$\nabla = 13,9$



C302/C302F

PUROTOUCH®
200 x 12,5 x 8 cm

LXX FLEX

$\nabla = 14,8$



C303/C303F

PUROTOUCH®
200 x 14 x 6,5 cm

LXX FLEX

$\sphericalangle = 15,4$



C218/C218F

PUROTOUCH®
200 x 15 x 13 cm

LXX FLEX

$\sphericalangle = 19,8$



C422

PUROTOUCH®
200 x 17 x 19,5 cm

LXX

$\sphericalangle = 25,9$



C301/C301F

PUROTOUCH®
200 x 17 x 14 cm

LXX FLEX

$\sphericalangle = 22$



C219

PUROTOUCH®
200 x 17,5 x 13 cm

LXX

$\sphericalangle = 21,9$



C307

PUROTOUCH®
200 x 19 x 19 cm

LXX

$\sphericalangle = 26,9$



C307 + C307A

C307 PUROTOUCH®
C307A DUROPOLYMER®
C307 - 200 x 19 x 19 cm
C307A - 7,5 x 9,5 x 4 cm

LXX

$\sphericalangle = 26,9$



C308/C308F

PUROTOUCH®
200 x 25 x 6 cm

LXX FLEX

$\sphericalangle = 25,7$



CX160

DUROPOLYMER®
200 x 1,3 x 4 cm



∇ = 4,2



CX161

DUROPOLYMER®
200 x 1,3 x 7 cm



∇ = 11,3



CX132

DUROPOLYMER®
200 x 2 x 2 cm



∇ = 2,8



CX133

DUROPOLYMER®
200 x 2 x 2 cm



∇ = 2,8



CX111

DUROPOLYMER®
200 x 2,5 x 1,5 cm



∇ = 2,9



PX164

DUROPOLYMER®
200 x 3 x 2,5 cm



∇ = 3,9



CX115

DUROPOLYMER®
200 x 3 x 3 cm



∇ = 4,2



CX154

DUROPOLYMER®
200 x 3 x 3 cm



∇ = 4,2





CX148

DUROPOLYMER®
200 x 3 x 4,5 cm

∇ = 5,4



CX110

DUROPOLYMER®
200 x 4,5 x 4 cm

∇ = 6



CX109

DUROPOLYMER®
200 x 4,5 x 4,5 cm

∇ = 6,4



CX124

DUROPOLYMER®
200 x 5 x 5 cm

∇ = 7,1



CX112

DUROPOLYMER®
200 x 5,5 x 4 cm

∇ = 7,1



CX108

DUROPOLYMER®
200 x 5,5 x 5,5 cm

∇ = 7,8



CX100

DUROPOLYMER®
200 x 7 x 7 cm

∇ = 9,9



CX123

DUROPOLYMER®
200 x 8 x 8 cm

∇ = 11,3



CX126

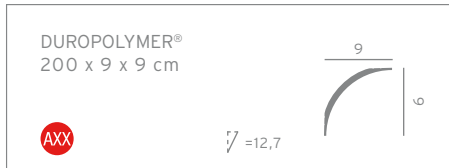

CX127

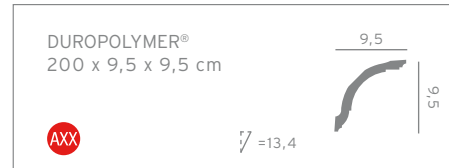

CX106

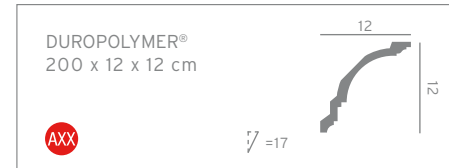

CX101

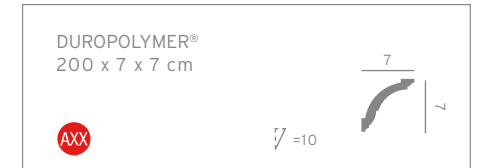

CX136

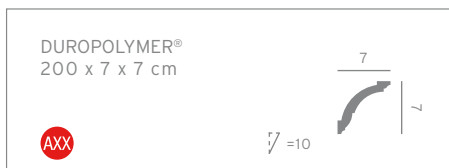

CX128

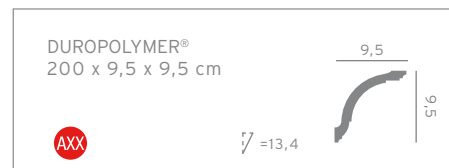

CX129

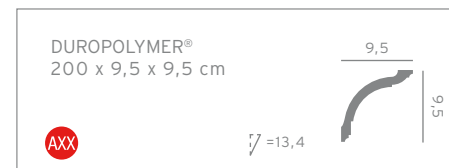

CX107

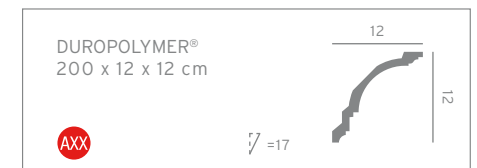



DX162-2300

DUROPOLYMER®
230 x 1 x 4 cm



4
1 1/2



DX159-2300

DUROPOLYMER®
230 x 1,2 x 6 cm



6
1 1/2



DX157-2300

DUROPOLYMER®
230 x 1,3 x 6,5 cm



6,5
1 1/2



DX163-2300

DUROPOLYMER®
230 x 1,3 x 10 cm



10
1 1/2





CB500

DUROFOAM®
200 x 2,5 x 2 cm

BXX

∇ = 3,2



CB530

DUROFOAM®
200 x 2,7 x 1,5 cm

BXX NEW

∇ = 3,1



CB530

DUROFOAM®
200 x 2,7 x 1,5 cm

BXX NEW

∇ = 3,1



CB520

DUROFOAM®
200 x 3,5 x 3,5 cm

BXX

∇ = 5



CB501

DUROFOAM®
200 x 4 x 3,5 cm

BXX

∇ = 5,3



CB510

DUROFOAM®
200 x 4 x 4 cm

BXX

∇ = 5,7



CB523

DUROFOAM®
200 x 6 x 4 cm

BXX

∇ = 7,2



CB531

DUROFOAM®
200 x 4,5 x 2,5 cm

BXX NEW

∇ = 5,2



CB531

DUROFOAM®
200 x 4,5 x 2,5 cm

BXX NEW

∇ = 5,2

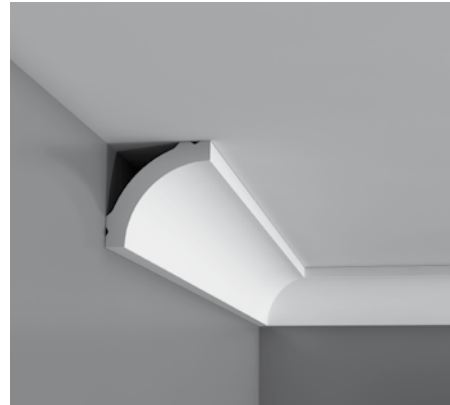

CB521

DUROFOAM®
200 x 5 x 5 cm

BXX

∇ = 7,1



CB502

DUROFOAM®
200 x 6 x 5 cm

BXX

∇ = 7,8



CB522

DUROFOAM®
200 x 7 x 7 cm

BXX

∇ = 9,9



CB511

DUROFOAM®
200 x 7 x 7 cm

BXX

∇ = 10

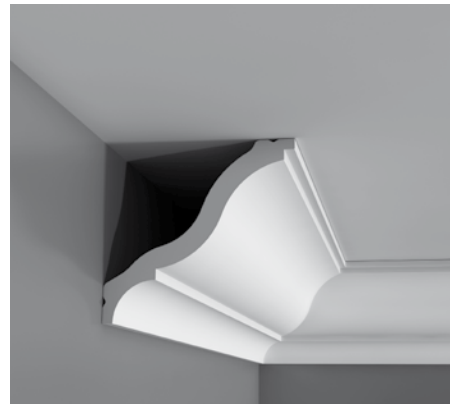

CB503

DUROFOAM®
200 x 8,5 x 9 cm

BXX NEW

∇ = 12,4



CB512

DUROFOAM®
CB512 - 200 x 10 x 10 cm
PB513 - 200 x 1,5 x 3,5 cm

BXX NEW

∇ = 14,1



PB513 + PB513A

PB513 - DUROFOAM®
PB513A - DUROPOLYMER®
PB513 - 200 x 1,5 x 3,5 cm
PB513A - 18 x 7 x 1,5 cm

BXX NEW



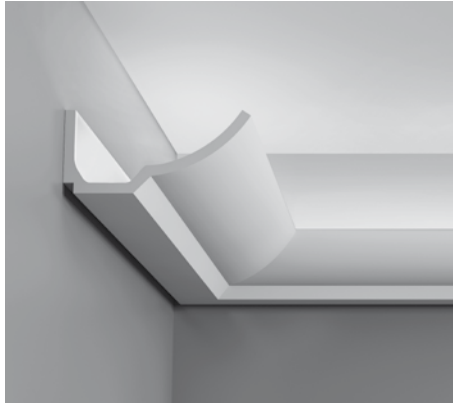

C351 - Designed by Jacques Vergracht

PUROTOUCH®
 200 x 8 x 17,5 cm

LXX

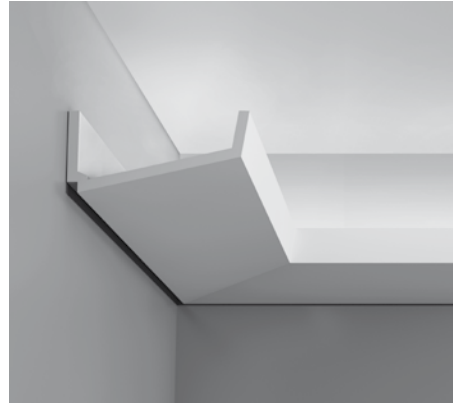

C352 - Designed by Jacques Vergracht

PUROTOUCH®
 200 x 7,5 x 17 cm

LXX

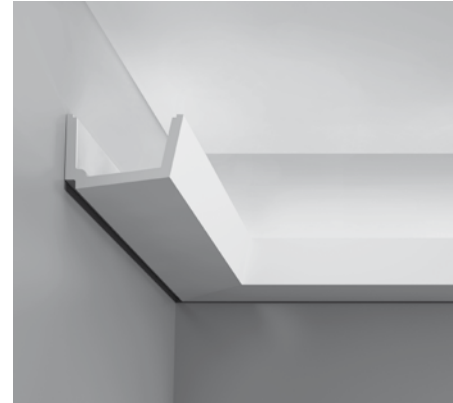

C357 - Designed by Jacques Vergracht

PUROTOUCH®
 200 x 7,5 x 11 cm

LXX

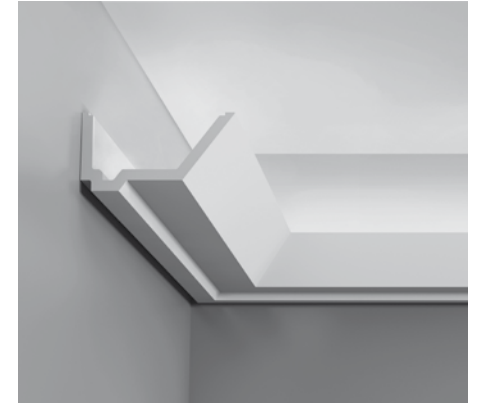

C358 - Designed by Jacques Vergracht

PUROTOUCH®
 200 x 7,5 x 14 cm

LXX



C361 - Designed by Pierre Daems

PUROTOUCH®
 200 x 5 x 5 cm

LXX NEW

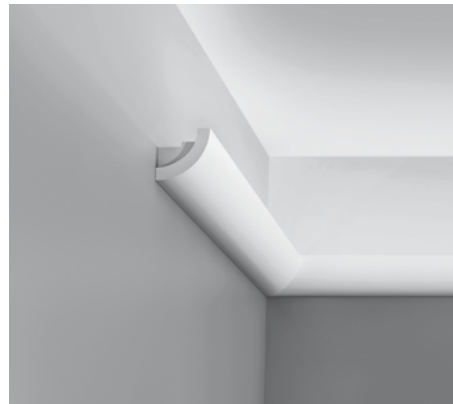

C362 - Designed by Pierre Daems

PUROTOUCH®
 200 x 5 x 5 cm

LXX NEW

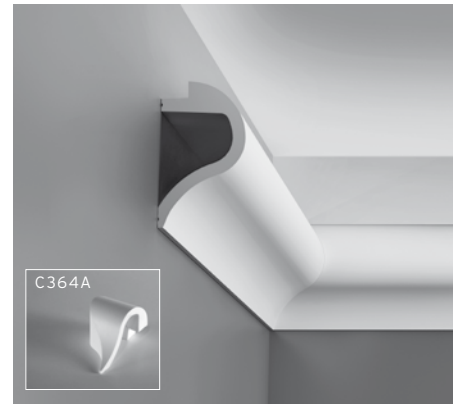

C364 - Designed by Pierre Daems

PUROTOUCH®
 200 x 14 x 8 cm

LXX NEW



C363 - Designed by Pierre Daems

PUROTOUCH®
 130 x 5 x 5 cm

LXX NEW



C900

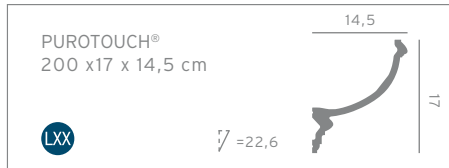

C901

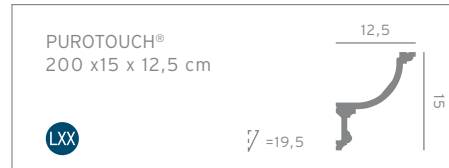

C902

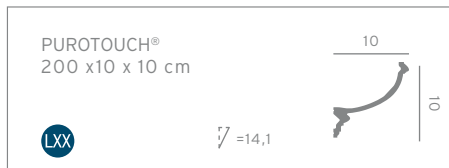

IL000-001

5x plexi cover voor C357, L 100cm
5x couvertures en plexi pour C357, L 100cm
5 x plexi cover for C357, L 100cm
5 x Plexi Abdeckung für C357, L 100cm
5 x plexiglas para C357, L 100cm

IL000-002

5x plexi cover voor C358, L 100cm
5x couvertures en plexi pour C358, L 100cm
5 x plexi cover for C358, L 100cm
5 x Plexi Abdeckung für C358, L 100cm
5 x plexiglas para C358, L 100cm



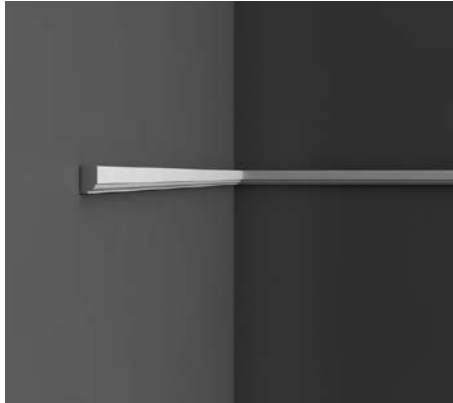

P9050/P9050F

PUROTOUCH®
200 x 2,5 x 1,5 cm

LXX FLEX

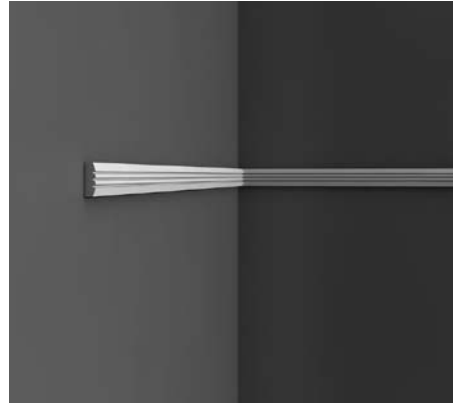

P5021/P5021F

PUROTOUCH®
200 x 3 x 1 cm

LXX FLEX

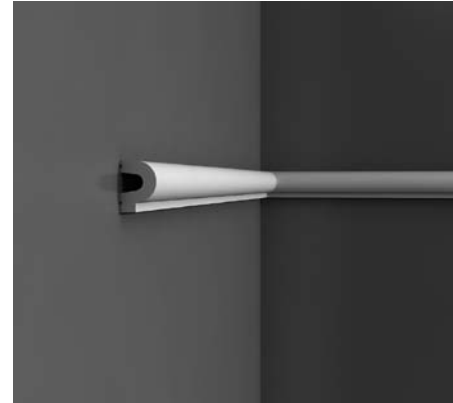

P8060/P8060F

PUROTOUCH®
200 x 3,5 x 5 cm

LXX FLEX NEW

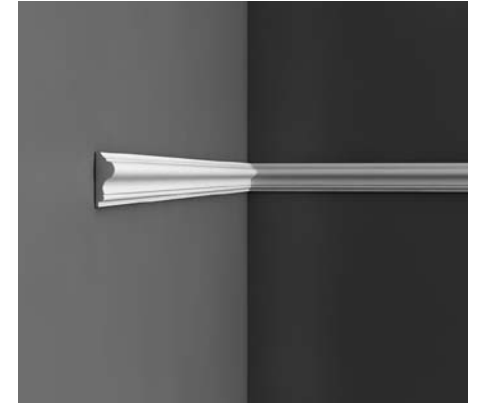

P8030/P8030F

PUROTOUCH®
200 x 4 x 1,5 cm

LXX FLEX

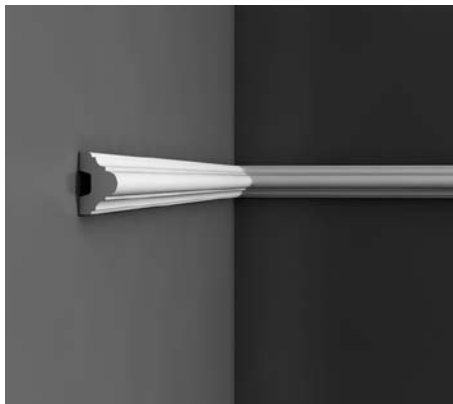

P4020/P4020F

PUROTOUCH®
200 x 5 x 3 cm

LXX FLEX

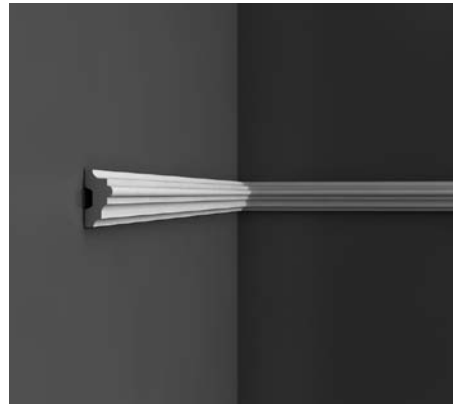

P9040/P9040F

PUROTOUCH®
200 x 5 x 2,5 cm

LXX FLEX



P8020/P8020F

PUROTOUCH®
200 x 6 x 2,5 cm

LXX FLEX

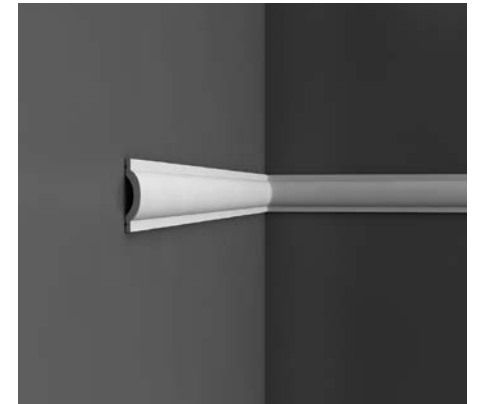

P9901/P9901F

PUROTOUCH®
200 x 7 x 1,5 cm

LXX FLEX

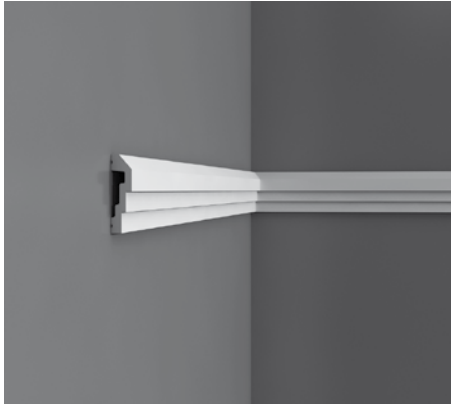

P7070/P7070F

PUROTOUCH®
200 x 7,5 x 2 cm

LXX FLEX

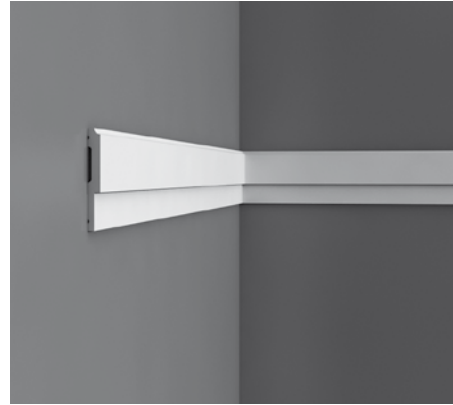

P9900/P9900F

PUROTOUCH®
200 x 8 x 1 cm

LXX FLEX

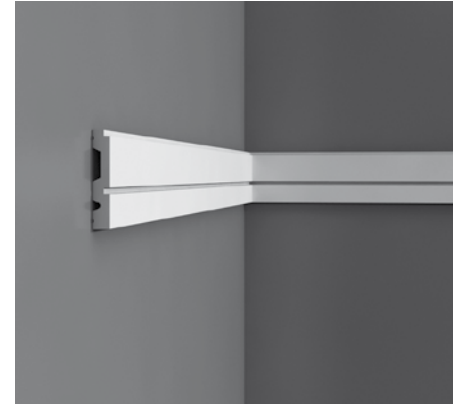

P5051

PUROTOUCH®
200 x 8,5 x 1,5 cm

LXX



P9010/P9010F

PUROTOUCH®
200 x 9 x 3 cm

LXX FLEX

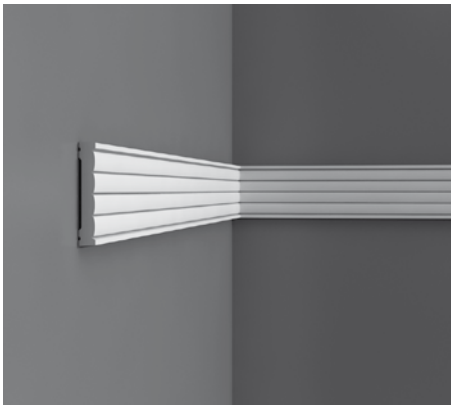

P5020/P5020F

PUROTOUCH®
200 x 9 x 1,5 cm

LXX FLEX

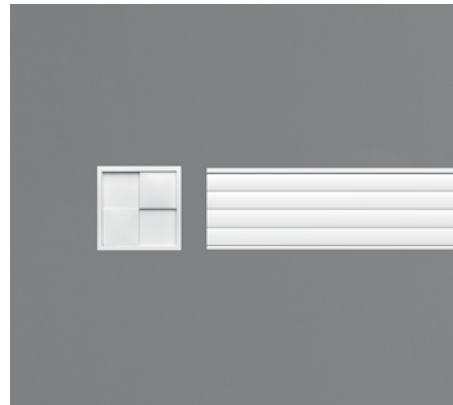

P5020A

PUROTOUCH®
9 x 9 x 1,5 cm
endcap for P5020

LXX

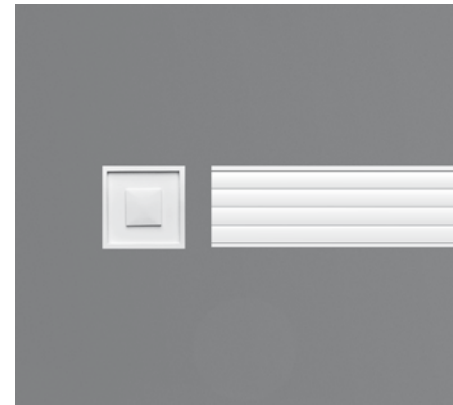

P5020B

PUROTOUCH®
9 x 9 x 1,5 cm
endcap for P5020

LXX NEW

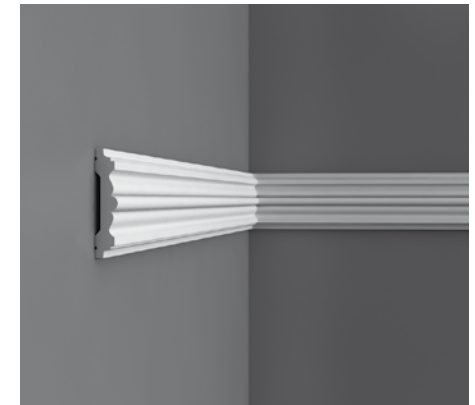

P9020/P9020F

PUROTOUCH®
200 x 9,5 x 2 cm

LXX FLEX

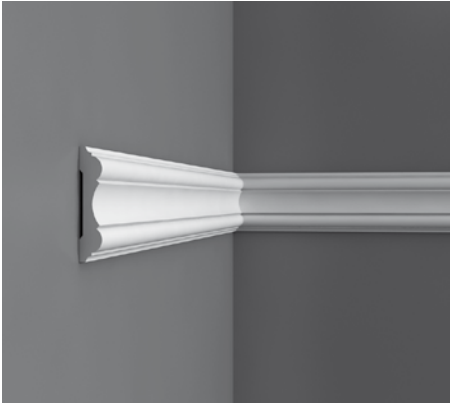

P8040/P8040F

PUROTOUCH®
200 x 10 x 2 cm

LXX FLEX

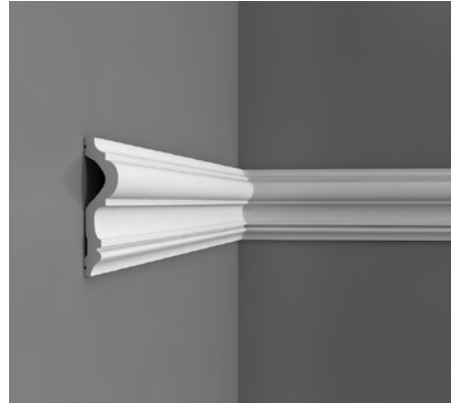

P8050/P8050F

PUROTOUCH®
200 x 12 x 3 cm

LXX FLEX



P5050

PUROTOUCH®
200 x 20 x 1,5 cm

LXX



P8030D

DUROPOLYMER®
13 x 13 x 1,5 cm

LXX



P8030C + P8030

P8030C-DUROPOLYMER®
19 x 5,5 x 1,5 cm
P8030-PUROTOUCH®

LXX



P4020A + P4020

PUROTOUCH®
200 x 5 x 3 cm

LXX



P801C + P8020

PUROTOUCH®
20 x 8,5 x 2,5 cm

LXX



P4020A

PUROTOUCH®
16,5 x 7 x 3 cm

LXX

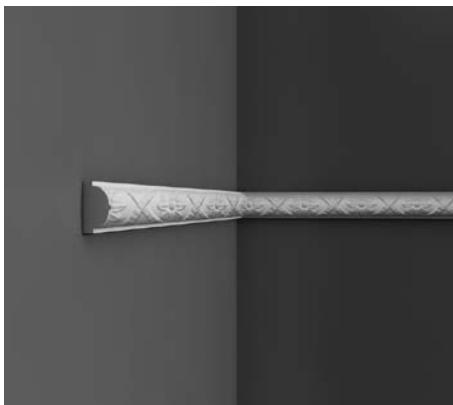

P2020/P2020F

PUROTOUCH®
200 x 4,5 x 2,5 cm

LXX FLEX



P1020/P1020F

PUROTOUCH®
200 x 5 x 2,5 cm

LXX FLEX



P7050/P7050F

PUROTOUCH®
200 x 5,5 x 2,5 cm

LXX FLEX

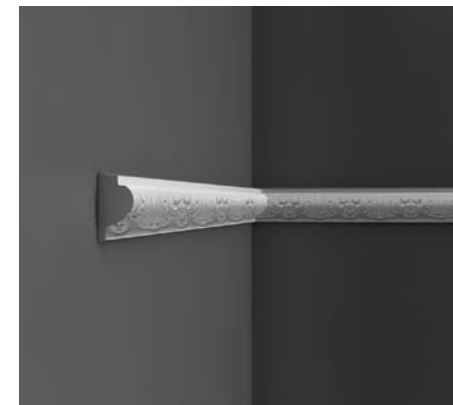

P3020/P3020F

PUROTOUCH®
200 x 6 x 3 cm

LXX

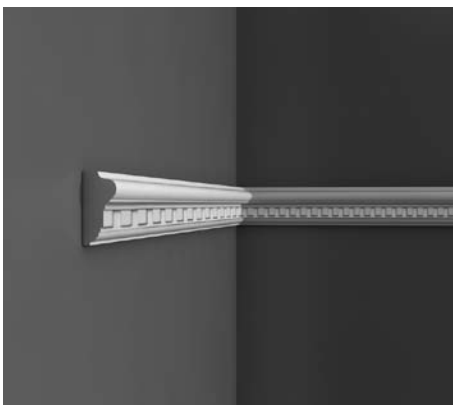

P6020/P6020F

PUROTOUCH®
200 x 6,5 x 3 cm

LXX FLEX



P7060/P7060F

PUROTOUCH®
200 x 7 x 2 cm

LXX FLEX



P7040/P7040F

PUROTOUCH®
200 x 8 x 2,5 cm

LXX FLEX



P7030/P7030F

PUROTOUCH®
200 x 8,5 x 1,5 cm

LXX FLEX

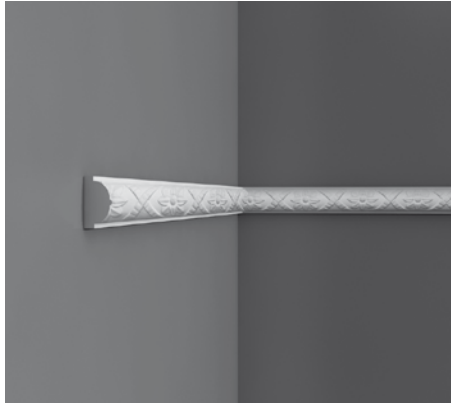

P2020/P2020F

PUROTOUCH®
200 x 4,5 x 2,5 cm



P21 + P201A

P21-DUROPOLYMER® + P201A-PUROTOUCH®
P21: 6,5 x 6,5 x 1 cm
P201A: 20 x 20 x 2,5 cm

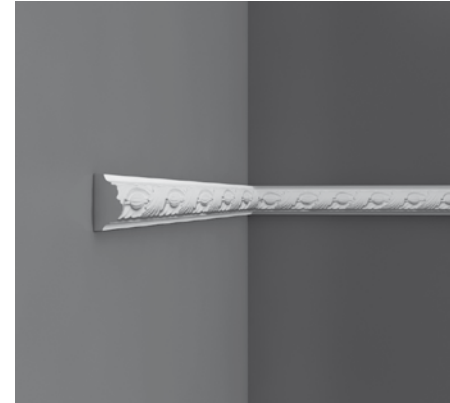

P1020/P1020F

PUROTOUCH®
200 x 5 x 2,5 cm

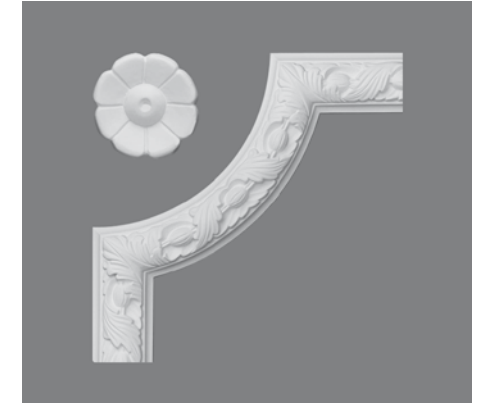

P20 + P101A

P20-DUROPOLYMER® + P101A-PUROTOUCH®
P20: diam. 6,5 cm
P101: 25 x 25 x 2,5 cm



P7010/P7010F

PUROTOUCH®
200 x 10,5 x 2 cm



P7020/P7020F

PUROTOUCH®
200 x 11 x 2 cm



P7080

PUROTOUCH®
200 x 22 x 2 cm





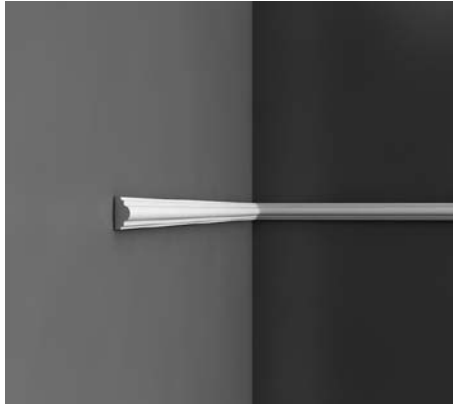

PX103

DUROPOLYMER®
200 x 2,5 x 1,5 cm

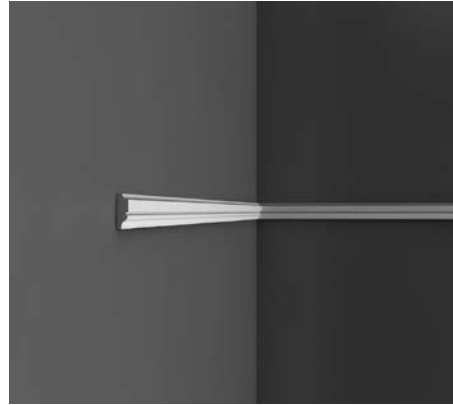

PX116

DUROPOLYMER®
200 x 3 x 1 cm

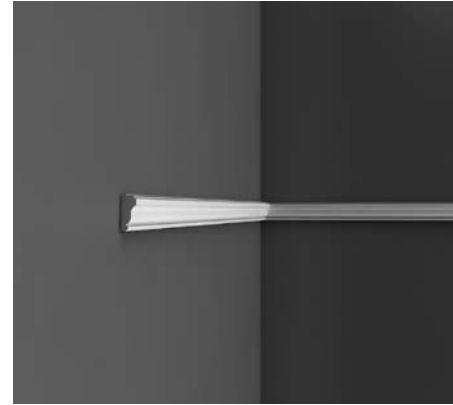

PX117

DUROPOLYMER®
200 x 3,5 x 1,5 cm

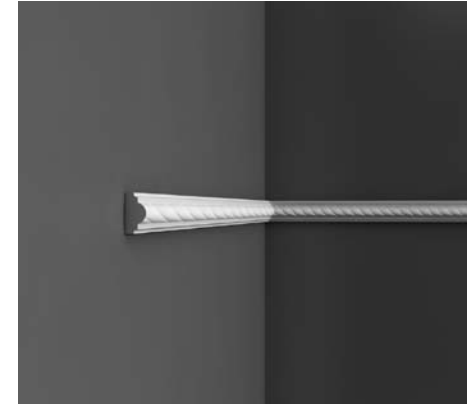

PX131

DUROPOLYMER®
200 x 4 x 2 cm



PX120

DUROPOLYMER®
200 x 4 x 2 cm



PX144

DUROPOLYMER®
200 x 5 x 1 cm



PX113

DUROPOLYMER®
200 x 6 x 2,5 cm



PX114

DUROPOLYMER®
200 x 6 x 2,5 cm



PX102

DUROPOLYMER®
200 x 8 x 1,5 cm

AXX

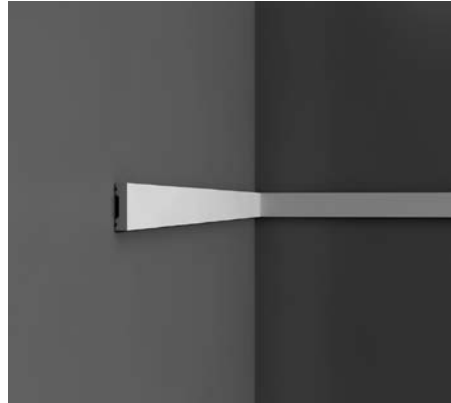

DX162-2300

DUROPOLYMER®
230 x 4 x 1 cm

AXX

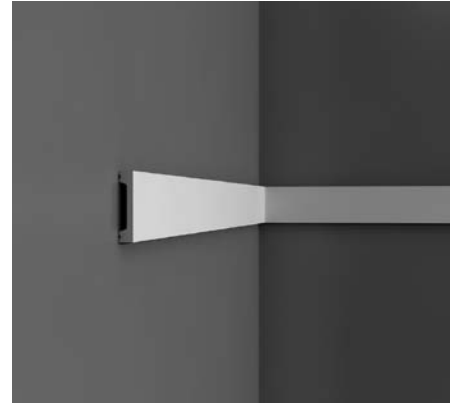

DX157-2300

DUROPOLYMER®
230 x 6,5 x 1,3 cm

AXX

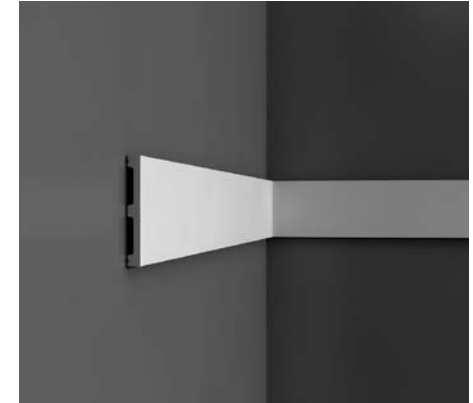

DX163-2300

DUROPOLYMER®
230 x 10 x 1,3 cm

AXX



PX103A + PX103

PX103A-PUROTOUCH® + PX103-DUROPOLYMER®
PX103 - 200 x 2,5 x 1,5 cm
PX103A - 19 x 3,5 x 1,3 cm

AXX



PX120A + PX120

PX120A-PUROTOUCH® + PX120-DUROPOLYMER®
PX120 - 200 x 4 x 2 cm
PX120A - 19 x 5,7 x 2 cm

AXX



PX164

DUROPOLYMER®
200 x 3 x 2,5 cm

AXX

for inner and outer corner use

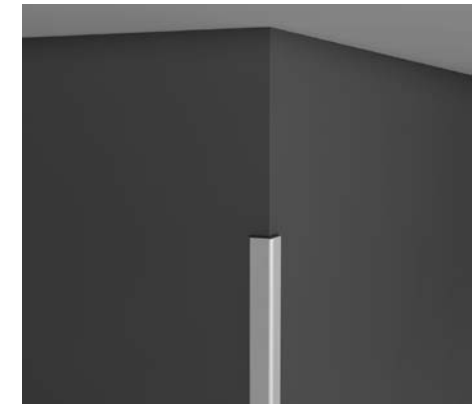

CX134



DUROPOLYMER®
200 x 3 x 3 cm

AXX





CX132

DUROPOLYMER®
200 x 2 x 2 cm



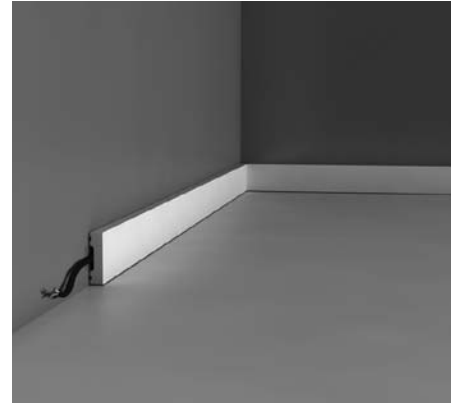

CX133

DUROPOLYMER®
200 x 2 x 2 cm

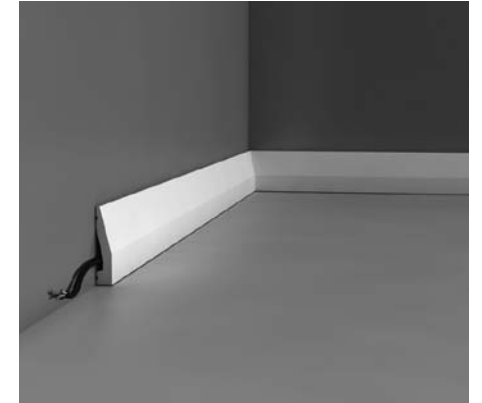

DX162-2300

DUROPOLYMER®
230 x 4 x 1 cm



DX159-2300

DUROPOLYMER®
230 x 6 x 1,2 cm

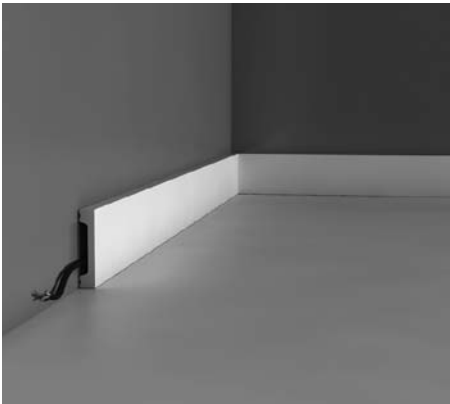

DX157-2300

DUROPOLYMER®
230 x 6,5 x 1,3 cm



SX125

DUROPOLYMER®
200 x 7 x 1,5 cm



SX122

200 x 8 x 2,2 cm



SX137

DUROPOLYMER®
200 x 10 x 1,5 cm



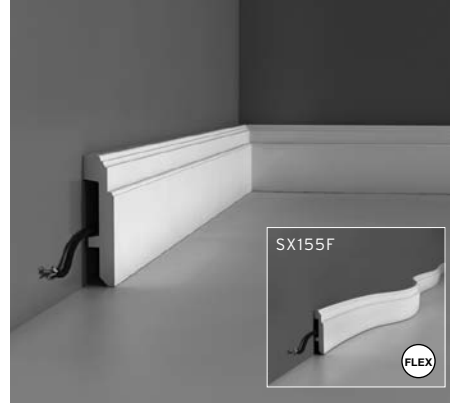
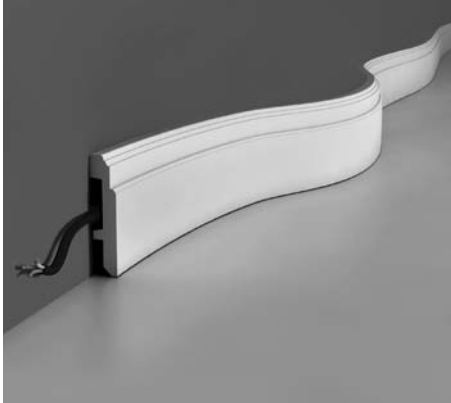

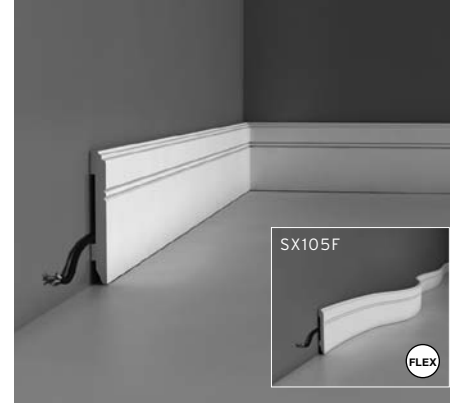
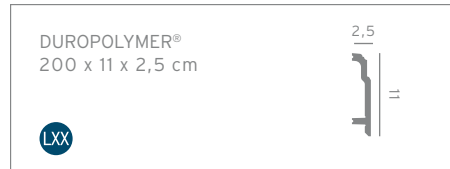
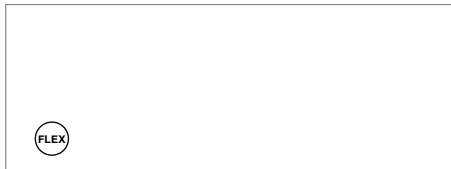

SX155

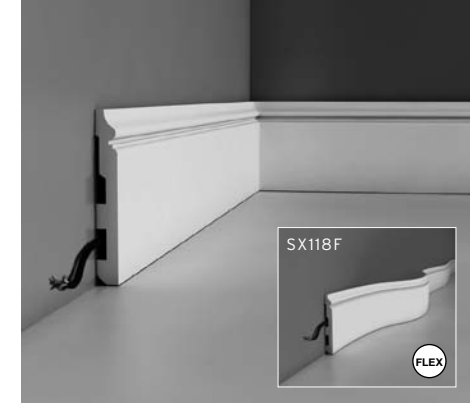
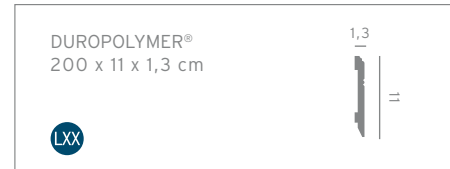

SX105



SX118

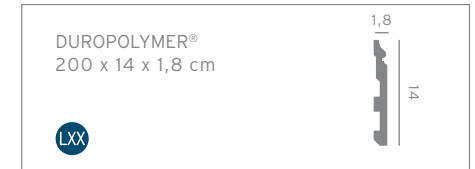

SX138

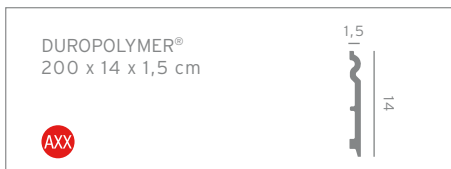

SX104

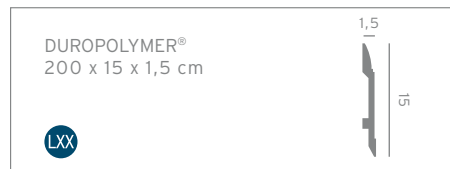

SX156 - Designed by Xavier Donck

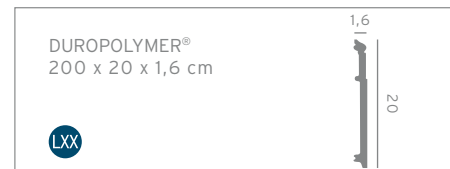

DX163-2300

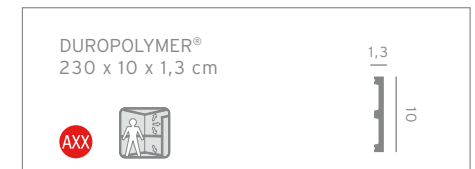

DRINK
Coca-Cola
ICE COLD



Orac Flex

Kroonlijsten / Corniches / Cornice
Mouldings / Eckleisten / Cornisas

	Rmin	R*min
C200F	1,2 m	
C201F	1,6 m	/
C211F	2,5 m	/
C212F	1,4 m	/
C213F	1,8 m	/
C214F	1,0 m	/
C215F	1,6 m	/
C216F	3,4 m	/
C217F	3,4 m	/
C218F	3,5 m	/
C220F	2,0 m	/
C230F	1,0 m	/
C240F	2,0 m	/
C250F	0,8 m	/
C260F	1,3 m	/
C301F	3,0 m	/
C302F	2,6 m	/
C303F	1,8 m	/
C304F	1,8 m	/
C305F	3,4 m	/
C308F	1,4 m	/
C321F	1,4 m	/
C322F	1,2 m	/
C331F	4,2 m	/
C333F	3,3 m	/
C334F	3,8 m	/
C339F	2,4 m	/
C402F	1,5 m	/
C602F	1,3 m	/
C901F	3,8 m	/
C902F	3,8 m	/

Wandlijsten / Cimaises / Panel Mouldings
/ Wand- und Friesleisten / Molduras

	Rmin	R*min
P1020F	0,4 m	1,2 m
P2020F	0,4 m	1,2 m
P3020F	0,8 m	1,8 m
P4020F	0,4 m	1,4 m
P5020F	0,4 m	/
P5021F	0,3 m	0,8 m
P6020F	0,4 m	2,0 m
P7010F	0,3 m	/
P7020F	0,3 m	/
P7030F	0,3 m	/
P7040F	0,5 m	/
P7050F	0,5 m	/
P7060F	0,4 m	/
P7070F	0,4 m	/
P8020F	0,5 m	2,0 m
P8030F	0,3 m	1,0 m
P8040F	0,3 m	/
P8050F	0,8 m	1,8 m
P8060F	0,8 m	2,0 m
P9010F	0,4 m	/
P9020F	0,4 m	/
P9040F	0,4 m	0,9 m
P9050F	0,3 m	1,0 m
P9900F	0,4 m	1,8 m
P9901F	0,4 m	1,8 m

	Rmin	R*min
SX105F	0,4 m	/
SX118F	0,4 m	/
SX155F	0,4 m	/

Plinten / Plinthes / Skirting /
Sockelleisten / Zócalos

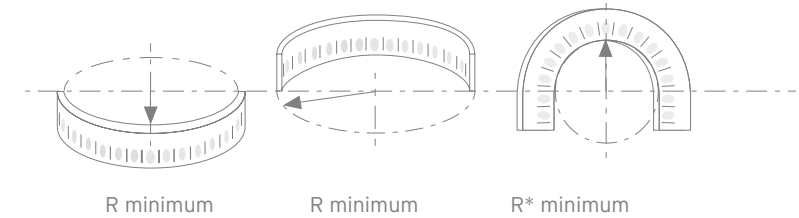

NL

ORAC FLEX, DE STIJLVOLLE OPLOSSING VOOR GEBOGEN EN AFGERONDE MUREN

Hierbij een overzicht van alle Luxxus wand- en kroonlijsten en plinten die in flexibele polyurethaan gerealiseerd kunnen worden. Door deze buigzaamheid kunnen gebogen wanden en plafonds elegant afgewerkt worden. Men kan ook gebogen ornamenten op een vlakke wand of plafond aanbrengen. De flexibele lijsten zijn op dezelfde manier af te werken als de gewone lijsten. Installatie-instructies zijn verkrijgbaar.

FR

ORAC FLEX, LA SOLUTION ÉLÉGANTE POUR LES MURS CINTRÉS ET ARRONDIS

Voici un aperçu des corniches, cimaises et plinthes Luxxus existantes qui sont réalisées dans un polyuréthane flexible. Par leur souplesse, elles permettent de décorer les murs et plafonds arrondis. Ces moulures peuvent être décorées de la même façon que les autres moulures. Des modes d'emploi sont disponibles.

EN

ORAC FLEX, THE ELEGANT SOLUTION FOR ROUNDED AND CURVED WALLS

Please find hereby an overview of all Luxxus cornices, panel mouldings and skirting boards which can also be made out of flexible polyurethane. Thanks to the flexibility of this material, it is now possible to decorate rounded walls and ceilings elegantly. These cornice and wall mouldings can be finished using the same methods as with the normal polyurethane mouldings. Installation instructions are available.

DE

ORAC FLEX, DIE IDEALE LÖSUNG FÜR GEBOGENE WÄNDE UND RUNDUNGEN

Diese Übersicht zeigt Ihnen alle Luxxus Wand-, Eck- und Sockelleisten, die in flexiblem Polyurethan erhältlich sind. Durch die Flexibilität der Profile können gebogene Wände und Decken elegant bearbeitet werden. Erstmals besteht die Möglichkeit, unebene Wände, Rundungen oder auch selbstentworfenen Kurvenverläufe entsprechend mit flexiblen Leisten zu dekorieren. Die flexiblen Profile sind auf die selbe Art zu installieren wie die normalen PU-Profile. Installationshinweise sind erhältlich.

ES

ORAC FLEX, LA INNOVACIÓN DE ORAC PARA DAR SOLUCIÓN A INSTALACIONES CON CURVAS

Columnas, Arcos, etc. Presentamos una amplia gama de cornisas, molduras, y zócalos Luxxus fabricados en poliuretano flexible. Por su flexibilidad, permiten dar soluciones en decoración a paredes y techos con curvas. Perfecta combinación entre el mismo modelo rígido y flexible. Consultar las instrucciones de instalación.

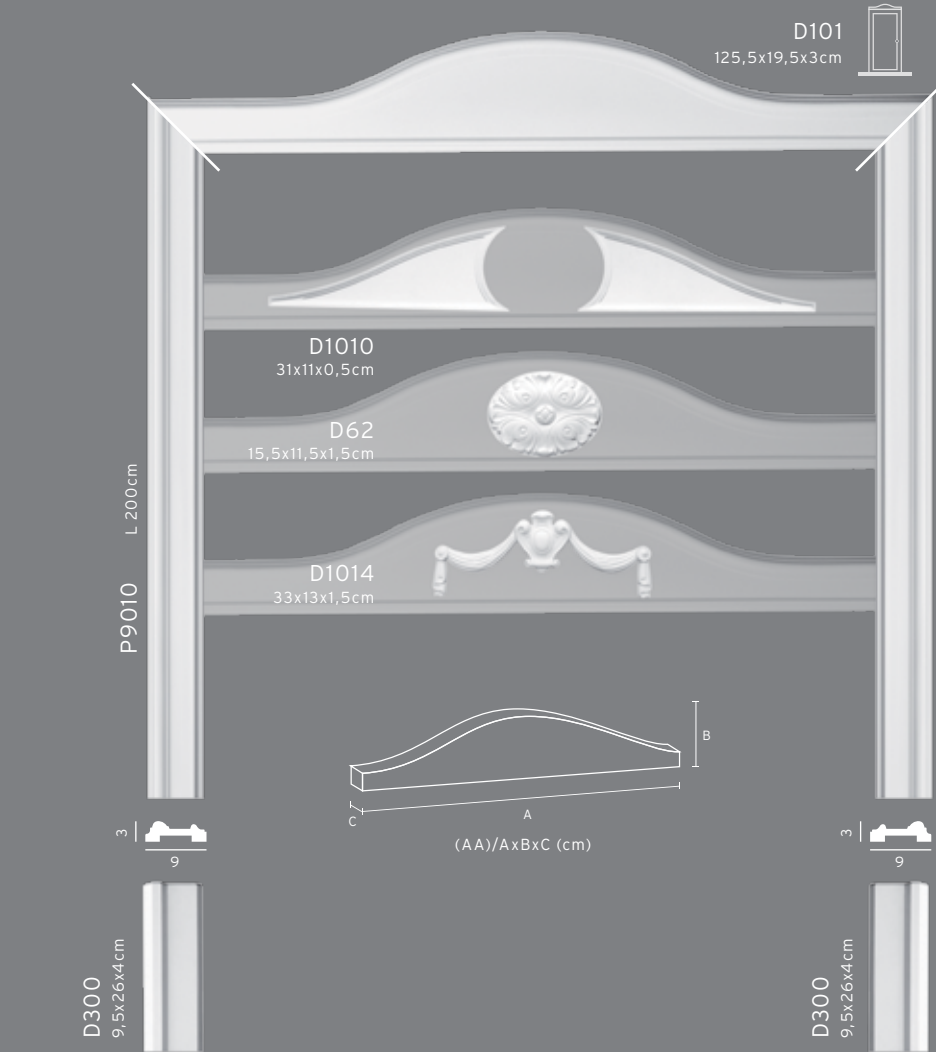

D210
9,5x9,5x3cm



DX121-2300



L 230cm



D200
9,5x9,5x3cm



2,3
9,3

D310
9,5x25x3cm

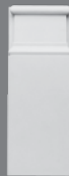

DX119-2300
L 230cm



DX121-2300
L 230cm



2,3
9,3

D310
9,5x25x3cm



2,3
9,3

KITS

kit KX001

- 1 x DX119, L 107cm
- 2 x DX119, L 213 cm
- 2 x D200 (9,5 x 9,5 x 3 cm)

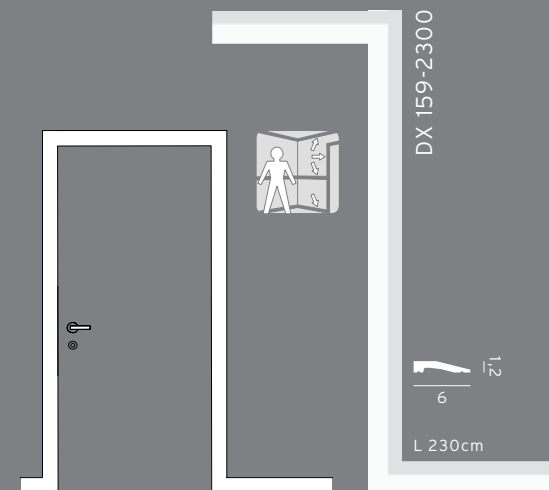
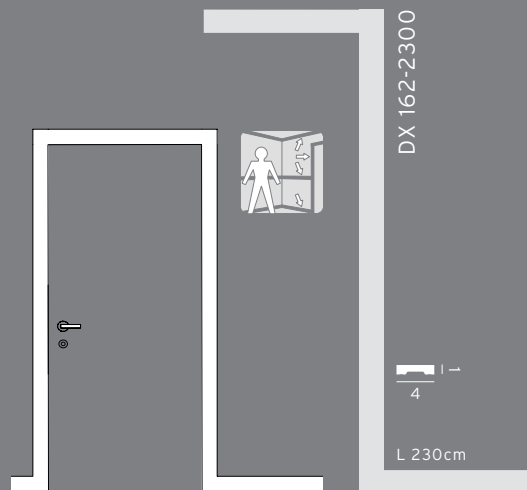
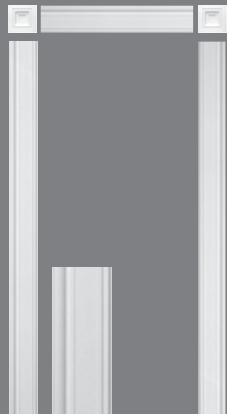

kit KX003

- 1 x DX119, L 107cm
- 2 x DX119, L 190 cm
- 2 x D200 (9,5 x 9,5 x 3 cm)
- 2 x D310 (9,5 x 25 x 3 cm)

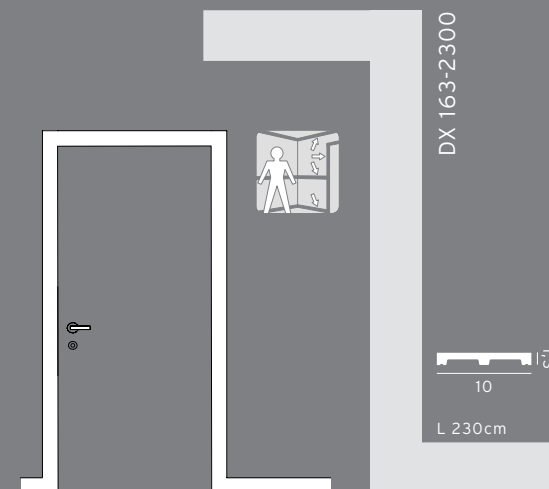
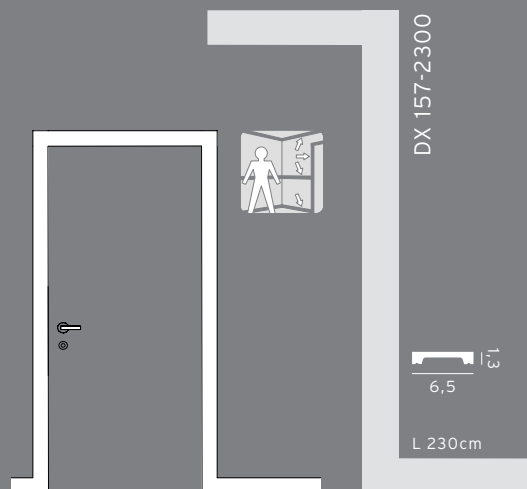



D140
PUROTOUCH®
99 x 32 x 2 cm

LXX



D120
PUROTOUCH®
124/113 x 25 x 9 cm

LXX



D150
PUROTOUCH®
100,5 x 15,5 x 1,5 cm

LXX



D400
PUROTOUCH®
127,5/122 x 14,5 x 5,5 cm

LXX



D161
PUROTOUCH®
92 x 21,5 x 4 cm

LXX



D401
PUROTOUCH®
127,5/122 x 14,5 x 5,5 cm

LXX



D170
PUROTOUCH®
105 x 25 x 3,5 cm

LXX





D402
PUROTOUCH®
12,7 x 14,5 x 6 cm
(only for D400 and D401)

LXX



D400 + D402
PUROTOUCH®
127,5/122 x 14,5 x 5,5 cm

LXX



2 x D401 + D402
PUROTOUCH®
max. 245,5/240 x 14,5 x 5,5 cm

LXX



K201/L
(H 15cm)

K201/R
(H 15cm)



K200

K200* L: MAX. 200cm

*K200 > p. 121





M9010L, M9010A, M9010R
D200, P9010, D300, D503, D504, SX118
DUROPOLYMER®

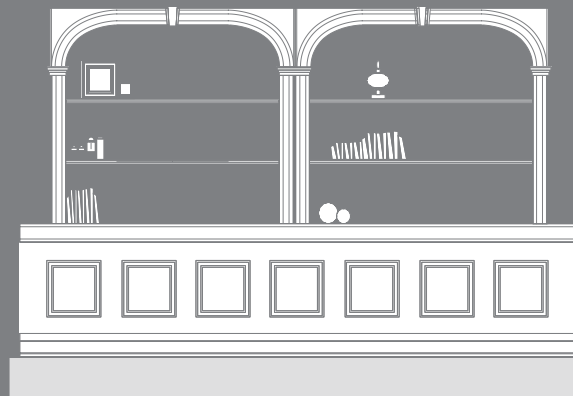

M9010L, M9010A, M9010R, M9010B, M9010C
P9010, P9020, D506, SX105
DUROPOLYMER®

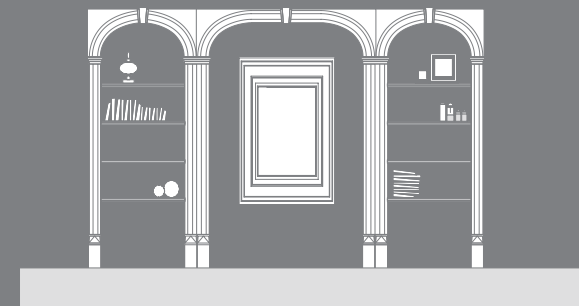

M9010L, M9010A, M9010R, M9010B, M9010C
P9010, D300
DUROPOLYMER®



M9010L, M9010A, M9010R
K200, K201, D320, P9010
DUROPOLYMER®



M9010L, M9010A, M9010R, M9010B, M9010C
K201, K200, K202, P9010, D300
DUROPOLYMER®



M9010L, M9010A, M9010R, M9010B
P9010
DUROPOLYMER®



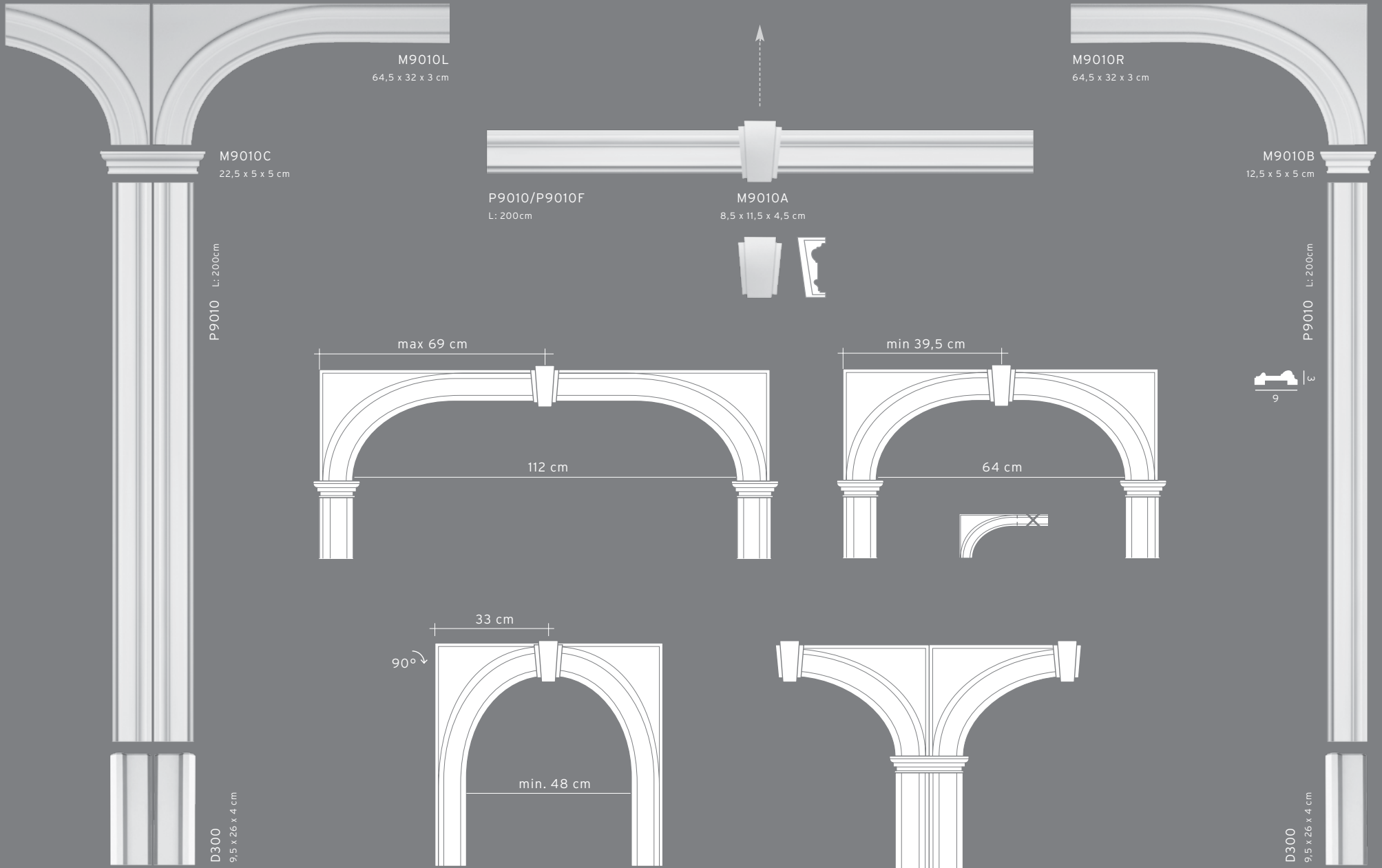



D500
DUROPOLYMER®
55 x 75 x 1,5 cm

LXX

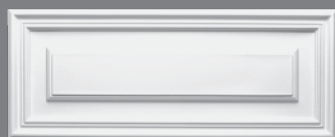

D504
DUROPOLYMER®
55 x 22 x 1,5 cm

LXX



D503
DUROPOLYMER®
55 x 55 x 1,5 cm

LXX



D507
DUROPOLYMER®
55 x 90,5 x 1,5 cm

LXX



D506
DUROPOLYMER®
43 x 43 x 1,5 cm

LXX

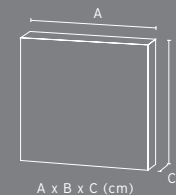

F30
PUROTOUCH®
60,5 x 60,5 x 4 cm

LXX



F31
PUROTOUCH®
59,5 x 59,5 x 6,5 cm

LXX



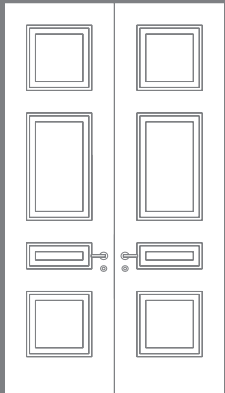

D503, D504

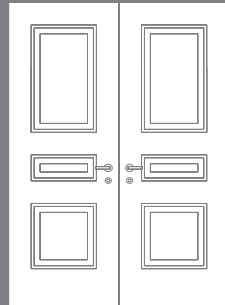

D507, D503, D504

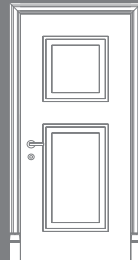

DX121
D503, D507

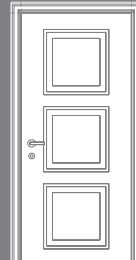

DX119
D503

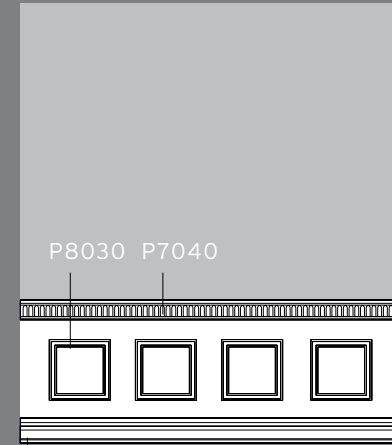

SX118
DX121-2300

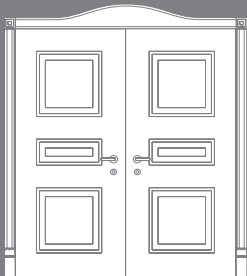

D310

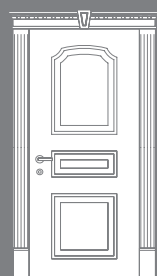

D320

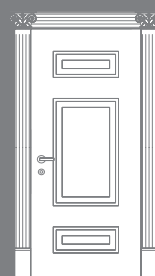

D320



D300

D200, D102, D503, D504



D401, D402, K200
D500, D504, D503



K201L, K200, K201R
D504, D507



D200, P9010, D310
D504, D503, D507

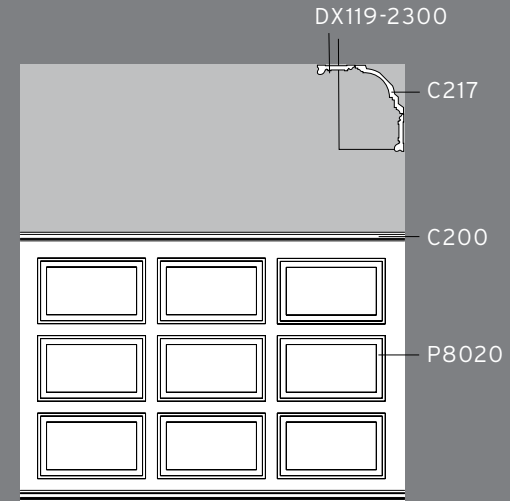

C217

C200

P8020



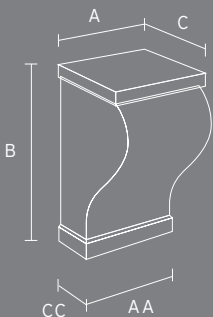

A x B x C (cm)
AA x CC (cm)

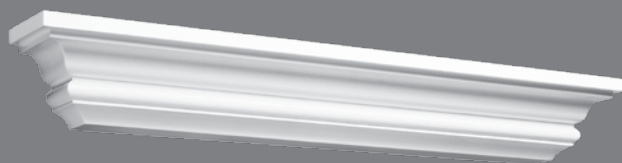

B417
PUROTOUCH®
90,5 x 13,5 x 14 cm

LXX



B408
PUROTOUCH®
22,5 x 40 x 13 cm

LXX



B404
PUROTOUCH®
19,5 x 31,5 x 11,5 cm

LXX



B403
PUROTOUCH®
19 x 19 x 10 cm

LXX



B402
PUROTOUCH®
9 x 22 x 7 cm

LXX



B401
PUROTOUCH®
11,5 x 15,5 x 7 cm

LXX



B409
PUROTOUCH®
30 x 35 x 17,5 cm

LXX



B413
PUROTOUCH®
16 x 22,5 x 8,5 cm

LXX



B414
PUROTOUCH®
10 x 22 x 7 cm

LXX



B410
PUROTOUCH®
19,5 x 50 x 16 cm

LXX



H100
PUROTOUCH®
114,5 x 129,5 x 20,5 cm

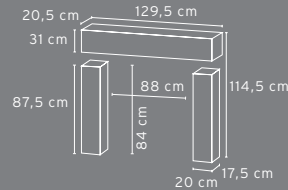

H101
PUROTOUCH®
110 x 129 x 20 cm

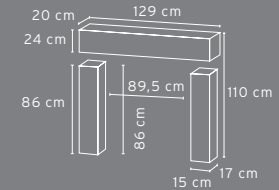

max. 2 à 3 kW

De sierschouwen zijn **enkel als decoratief element bedoeld** en mogen uitsluitend geplaatst worden in combinatie met een elektrisch vuurtje van max. 2 à 3 kW.
 Les cheminées sont **des éléments décoratifs**. Elles peuvent seulement être employées avec un feu électrique de max. 2 à 3 kW.
 The fireplaces are **just as decorative purposes** and should only be installed in conjunction with an electric heater up to 2 to 3 kW.
 Die Kamine sind **nur als Dekorative Zwecke** und sollten nur in Verbindung mit einer elektrischen Heizung bis zu 2 bis 3 kW installiert werden.
 Las chimeneas **solamente deben utilizarse como elemento decorativo**. Se puede instalar un fuego eléctrico de potencia max. 2-3 Kw.

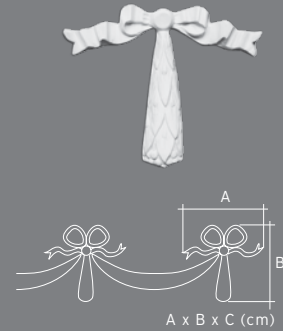

G40
DUROPOLYMER®
17 x 14 x 1,5 cm



G42
DUROPOLYMER®
40 x 4,5 x 1,5 cm



G50
PUROTOUCH®
54 x 39 x 3 cm



G51
PUROTOUCH®
73,5 x 9,5 x 3 cm





N403 / N404 / N410
PUROTOUCH®
N403 - 43 x 70,5 x 10 cm
N404 - 42 x 76 x 11 cm
N410 - 31 x 59,5 x 9,5 cm



N503 / N504 / N510 / N520
PUROTOUCH®
N503 - 69 x 112,5 x 11 cm
N504 - 69 x 113 x 11 cm
N510 - 55 x 98,5 x 18 cm
N520 - 55 x 97,5 x 18 cm



N504 + N510
PUROTOUCH®
N504 - 69 x 113 x 11 cm
N510 - 55 x 98,5 x 18 cm

N504 + N520
PUROTOUCH®
N504 - 69 x 113 x 11 cm
N520 - 55 x 97,5 x 18 cm

LXX

LXX

LXX

LXX

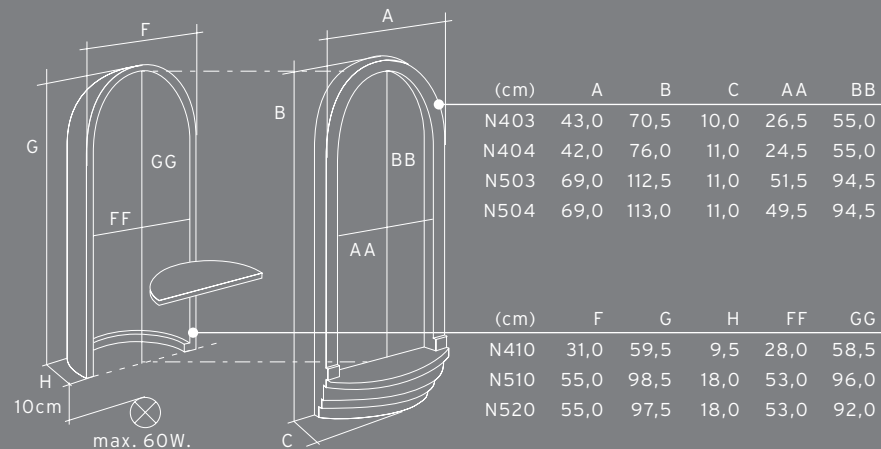

N503 + N510
PUROTOUCH®
N503 - 69 x 112,5 x 11 cm
N510 - 55 x 98,5 x 18 cm

N503 + N520
PUROTOUCH®
N503 - 69 x 112,5 x 11 cm
N520 - 55 x 97,5 x 18 cm

Plaats de gloeilamp (max. 60W) op min. 10cm afstand van de opale bodem.
Installez l'ampoule (max. 60W) à 10cm minimum du fond opaque.
Place the bulb (max. 60W) at least 10cm of soil opal.
Legen Sie die Glühbirne (max. 60W) mindestens 10 cm des Bodens Opal.
Instale la lámpara (max. 60W) como mínimo a 10 cms del fondo translúcido.

LXX

LXX





F30
PUROTOUCH®
60,5 x 60,5 x 4 cm*
*59,5 x 59,5 x 4 cm > info@oracdecor.com

LXX



F31
PUROTOUCH®
59,5 x 59,5 x 6,5 cm

LXX

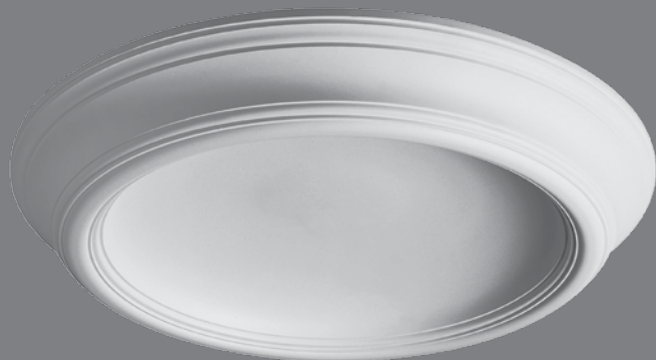

F10
PUROTOUCH®
11 x max. diam. 89,5

LXX

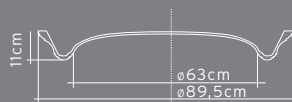

F11
PUROTOUCH®
9,5 x max. diam. 74,5

LXX

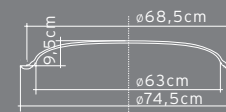

F12
PUROTOUCH®
33 x max. diam. 132

LXX

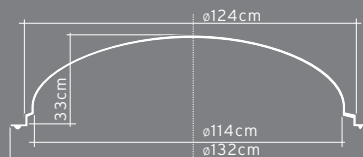

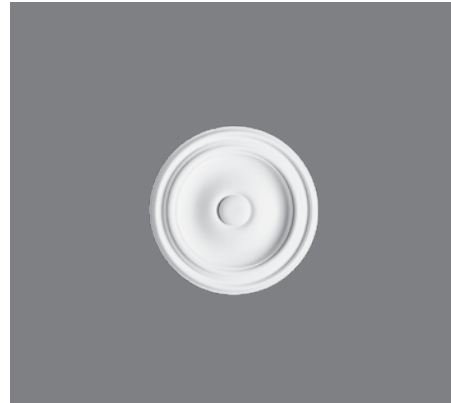
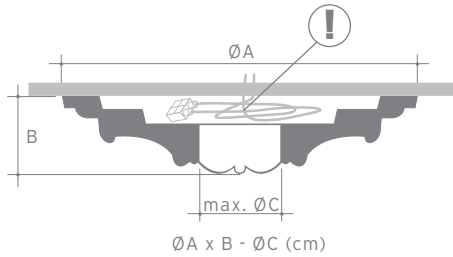

R07

PUROTOUCH®
Ø26 x 2,5 - Ø5cm



R08

PUROTOUCH®
Ø38 x 3,5 - Ø5cm



R09

PUROTOUCH®
Ø48,5 x 4 - Ø6cm



R66

PUROTOUCH®
Ø54,5/43 x 3,5



R76

PUROTOUCH®
Ø62 x 4 - Ø10,5cm



R40

PUROTOUCH®
Ø74,5 x 3,5 - Ø10cm



R35

PUROTOUCH®
Ø22 x 3



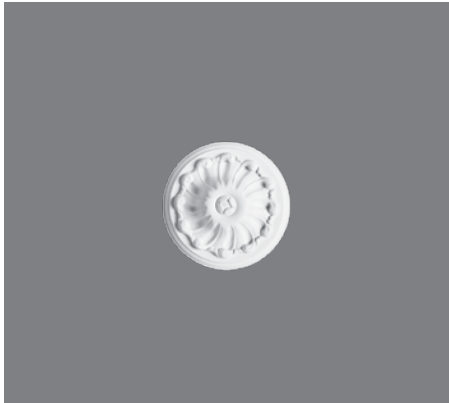

R10

PUROTOUCH®
Ø15 x 4 - Ø2cm



R11

PUROTOUCH®
Ø19 x 4 - Ø3cm

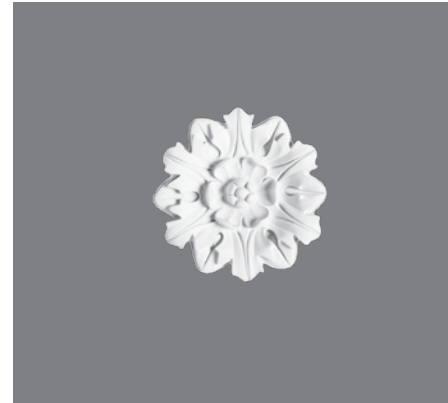

R12

PUROTOUCH®
Ø20 x 2 - Ø1cm



R13

PUROTOUCH®
Ø28,5 x 3,5 - Ø2,5cm



R50

PUROTOUCH®
Ø32 x 4 - Ø19cm



R14

PUROTOUCH®
Ø33,5 x 3 - Ø2,5cm



R31

PUROTOUCH®
Ø38,5 x 3 - Ø3,5cm



R61

PUROTOUCH®
Ø40 x 2,5 - Ø2,5cm



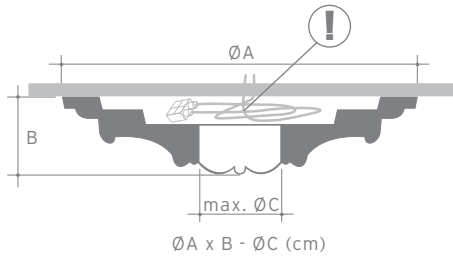

R16

PUROTOUCH®
Ø45 x 4 - Ø3cm



R17

PUROTOUCH®
Ø47 x 3,5 - Ø6,5cm



R18

PUROTOUCH®
Ø49 x 5 - Ø7cm



R46

PUROTOUCH®
Ø53,5 x 4 - Ø3cm



R22

PUROTOUCH®
(77 x 52,5) x 4cm



R77

PUROTOUCH®
Ø62 x 4,5 - Ø10,5cm



R74

PUROTOUCH®
Ø65,5 x 4 - Ø8cm





R52

PUROTOUCH®
Ø69,5 x 3,5 - Ø12,5cm



R38

PUROTOUCH®
Ø71 x 4,5 - Ø19cm



R28

PUROTOUCH®
Ø68,5 x 3,5 - Ø2cm



R73

PUROTOUCH®
Ø70 x 4 - Ø8cm



R23

PUROTOUCH®
Ø71,5 x 4 - Ø6cm



R27

PUROTOUCH®
Ø75 x 4,5 - Ø9cm



R24

PUROTOUCH®
Ø79 x 4 - Ø8cm



R64

PUROTOUCH®
Ø95,5 x 8 - Ø7cm





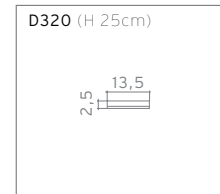
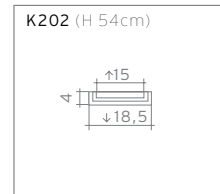
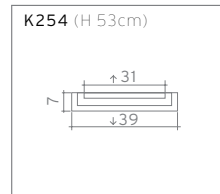
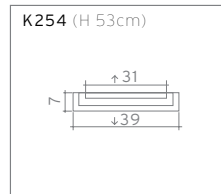
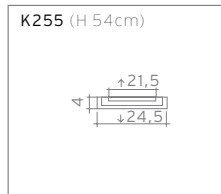
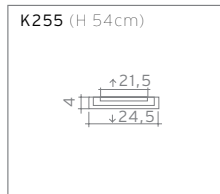
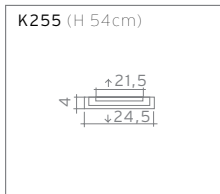
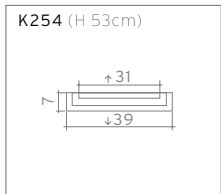
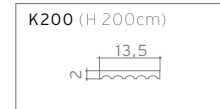
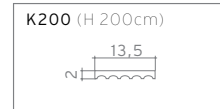
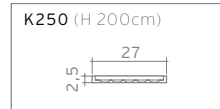
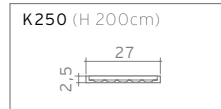
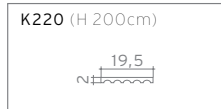
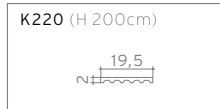
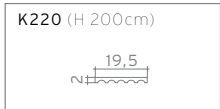
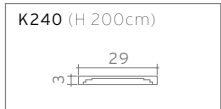
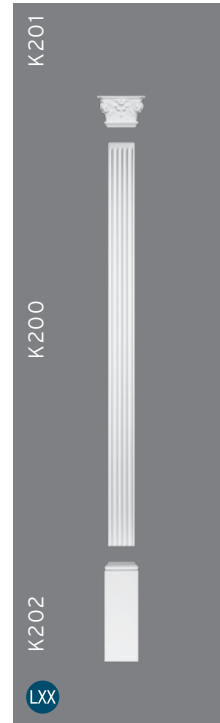
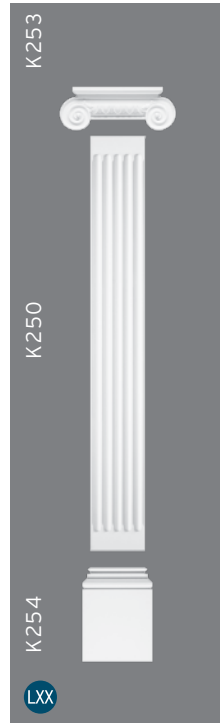
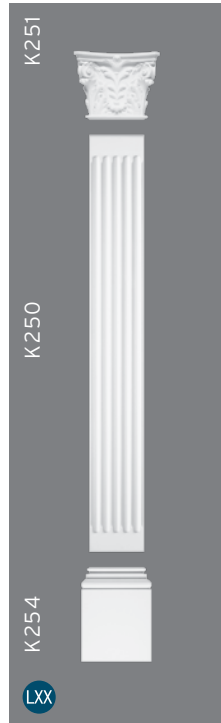
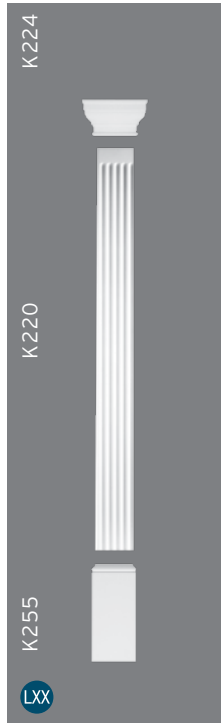
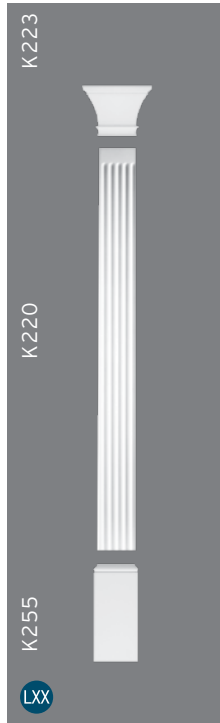
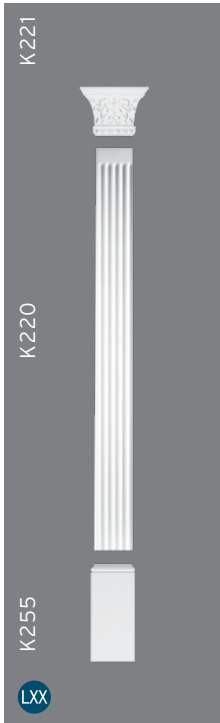
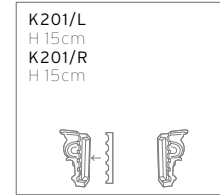
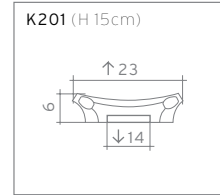
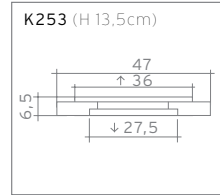
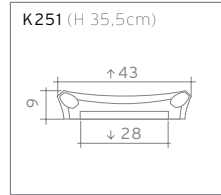
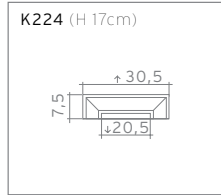
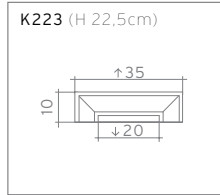
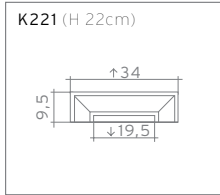
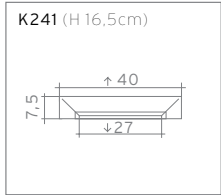



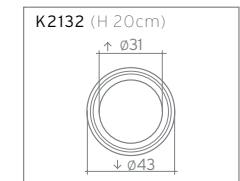
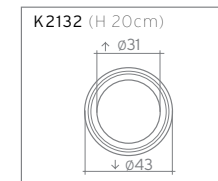
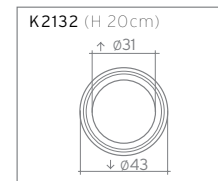
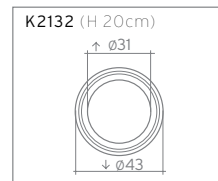
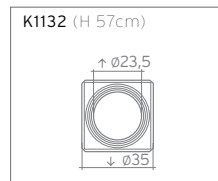
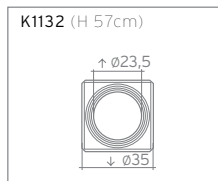
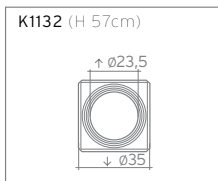
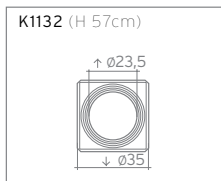
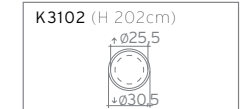
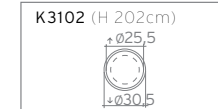
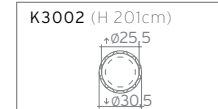
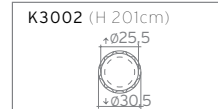
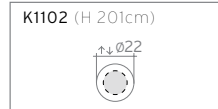
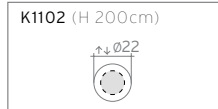
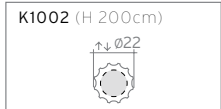
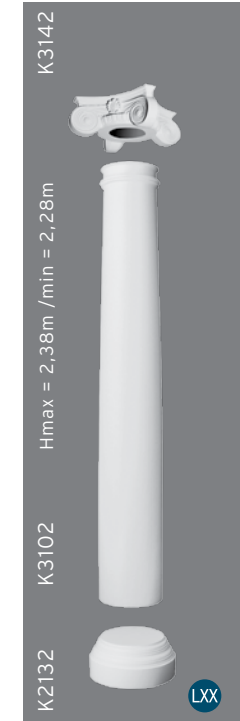
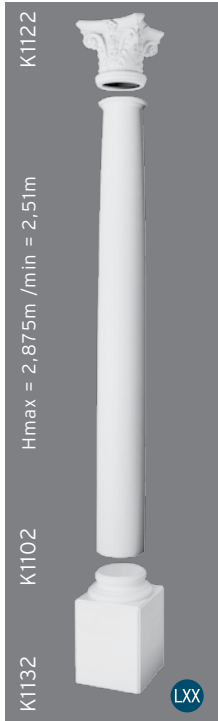
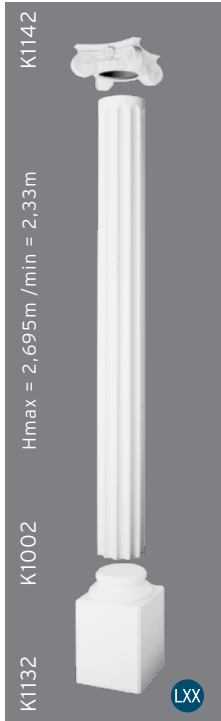
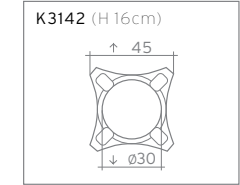
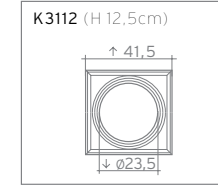
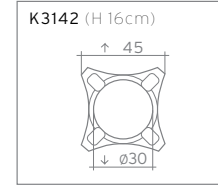
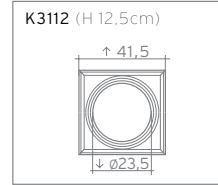
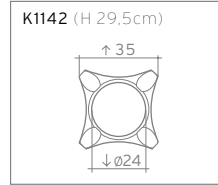
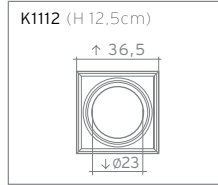
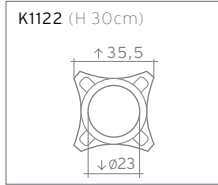
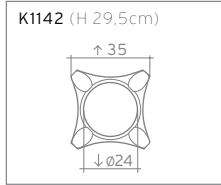



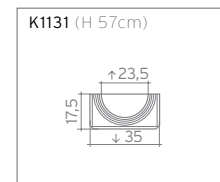
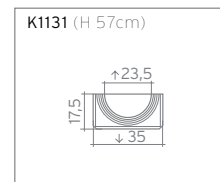
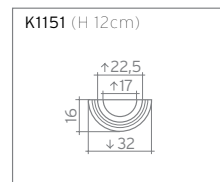
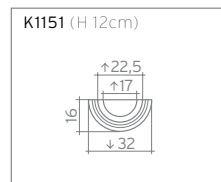
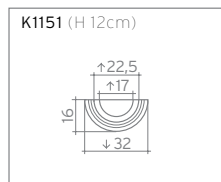
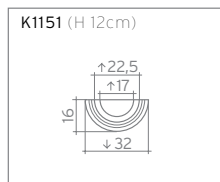
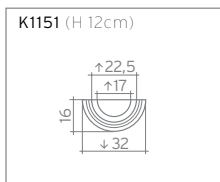
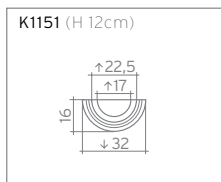
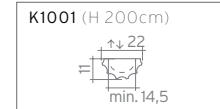
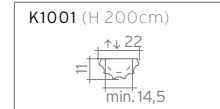
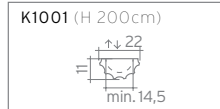
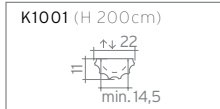
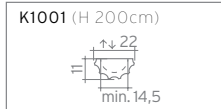
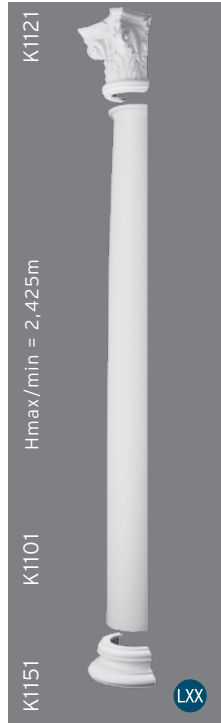
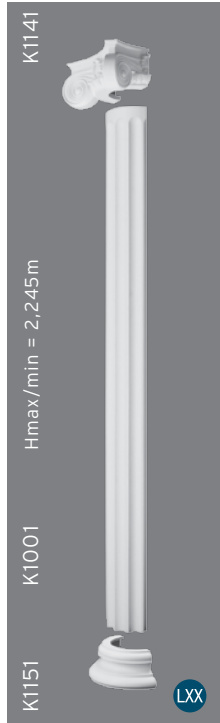
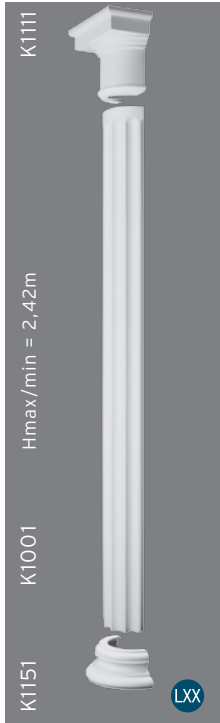
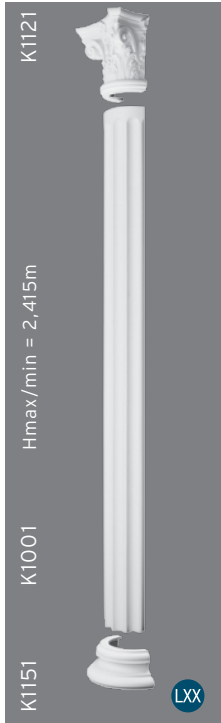
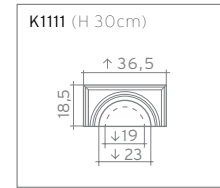
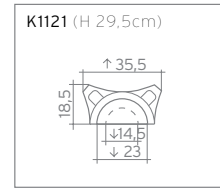
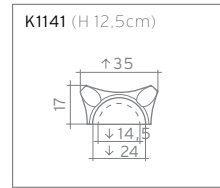
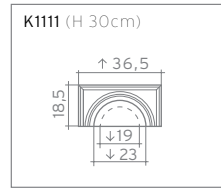
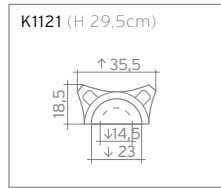
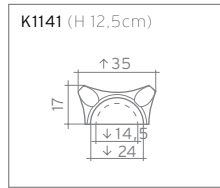
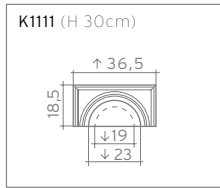
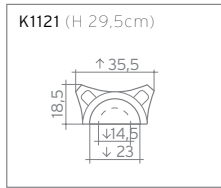

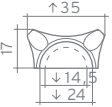
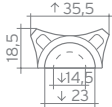
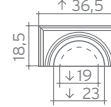
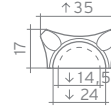
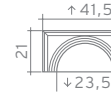
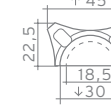
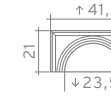
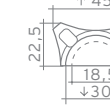













<p>K1122 (H 29,5cm)</p>	<p>K1112 (H 30cm)</p>	<p>K1142 (H 12,5cm)</p>	<p>K1122 (H 29,5cm)</p>	<p>K1112 (H 30cm)</p>	<p>K1142 (H 12,5cm)</p>	<p>K1122 (H 29,5cm)</p>	<p>K1112 (H 30cm)</p>
<p>K1122</p> <p>Hmax/min = 2,415m</p>	<p>K1112</p> <p>Hmax/min = 2,42m</p>	<p>K1142</p> <p>Hmax/min = 2,245m</p>	<p>K1122</p> <p>Hmax/min = 2,425m</p>	<p>K1112</p> <p>Hmax/min = 2,43m</p>	<p>K1142</p> <p>Hmax/min = 2,255m</p>	<p>K1122</p> <p>Hmax = 2,865m / min = 2,50m</p>	<p>K1112</p> <p>Hmax = 2,87m / min = 2,505m</p>
<p>K1002</p> <p>Hmax/min = 2,415m</p>	<p>K1002</p> <p>Hmax/min = 2,42m</p>	<p>K1002</p> <p>Hmax/min = 2,245m</p>	<p>K1102</p> <p>Hmax/min = 2,425m</p>	<p>K1102</p> <p>Hmax/min = 2,43m</p>	<p>K1102</p> <p>Hmax/min = 2,255m</p>	<p>K1002</p> <p>Hmax = 2,865m / min = 2,50m</p>	<p>K1002</p> <p>Hmax = 2,87m / min = 2,505m</p>
<p>K1152 (H 12cm)</p>	<p>K1152 (H 12cm)</p>	<p>K1152 (H 12cm)</p>	<p>K1152 (H 12cm)</p>	<p>K1152 (H 12cm)</p>	<p>K1152 (H 12cm)</p>	<p>K1132 (H 57cm)</p>	<p>K1132 (H 57cm)</p>

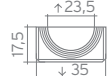

<p>K3112 (H 12,5cm)</p>	<p>K3142 (H 16cm)</p>	<p>K3112 (H 12,5cm)</p>	<p>K3142 (H 16cm)</p>	<p>K3112 (H 12,5cm)</p>	<p>K3142 (H 16cm)</p>	<p>K3112 (H 12,5cm)</p>	<p>K3142 (H 16cm)</p>
<p>K3112</p> <p>Hmax = 2,725m /min = 2,625m</p>	<p>K3142</p> <p>Hmax = 2,76m /min = 2,66m</p>	<p>K3112</p> <p>Hmax = 2,71m /min = 2,395m</p>	<p>K3142</p> <p>Hmax = 2,745m /min = 2,44m</p>	<p>K3112</p> <p>Hmax = 2,72m /min = 2,405m</p>	<p>K3142</p> <p>Hmax = 2,755m /min = 2,44m</p>	<p>K3112</p> <p>Hmax = 3,10m /min = 2,785m</p>	<p>K3142</p> <p>Hmax = 3,135m /min = 2,82m</p>
<p>K3202</p>	<p>K3202</p>	<p>K3002</p>	<p>K3002</p>	<p>K3102</p>	<p>K3102</p>	<p>K3202</p>	<p>K3202</p>
<p>K2132</p> <p>LXX</p>	<p>K2132</p> <p>LXX</p>	<p>K3152</p> <p>LXX</p>	<p>K3152</p> <p>LXX</p>	<p>K3152</p> <p>LXX</p>	<p>K3152</p> <p>LXX</p>	<p>K3152</p> <p>LXX</p>	<p>K3152</p> <p>LXX</p>
<p>K3202 (H 240cm)</p>	<p>K3202 (H 240cm)</p>	<p>K3002 (H 201cm)</p>	<p>K3002 (H 202cm)</p>	<p>K3102 (H 202cm)</p>	<p>K3102 (H 202cm)</p>	<p>K3202 (H 240cm)</p>	<p>K3202 (H 240cm)</p>
<p>K2132 (H 20cm)</p>	<p>K2132 (H 20cm)</p>	<p>K3152 (H 57,5cm)</p>	<p>K3152 (H 57,5cm)</p>	<p>K3152 (H 57,5cm)</p>	<p>K3152 (H 57,5cm)</p>	<p>K3152 (H 57,5cm)</p>	<p>K3152 (H 57,5cm)</p>

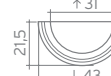

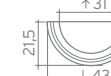
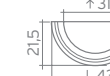
<p>K1141 (H 12,5cm)</p> 	<p>K1121 (H 29,5cm)</p> 	<p>K1111 (H 30cm)</p> 	<p>K1141 (H 12,5cm)</p> 	<p>K3111 (H 12,5cm)</p> 	<p>K3141 (H 16cm)</p> 	<p>K3111 (H 12,5cm)</p> 	<p>K3141 (H 16cm)</p> 
<p>K1141</p>  <p>Hmax = 2,695m / min = 2,33m</p> <p>K1101</p> <p>K1131 LXX</p>	<p>K1121</p>  <p>Hmax = 2,875m / min = 2,51m</p> <p>K1101</p> <p>K1131 LXX</p>	<p>K1111</p>  <p>Hmax = 2,88m / min = 2,515m</p> <p>K1101</p> <p>K1131 LXX</p>	<p>K1141</p>  <p>Hmax = 2,705m / min = 2,34m</p> <p>K1101</p> <p>K1131 LXX</p>	<p>K3111</p>  <p>Hmax = 2,355m / min = 2,235m</p> <p>K3001</p> <p>K2131 LXX</p>	<p>K3141</p>  <p>Hmax = 2,37m / min = 2,28m</p> <p>K3001</p> <p>K2131 LXX</p>	<p>K3111</p>  <p>Hmax = 2,345m / min = 2,245m</p> <p>K3001</p> <p>K2131 LXX</p>	<p>K3141</p>  <p>Hmax = 2,38m / min = 2,28m</p> <p>K3001</p> <p>K2131 LXX</p>
<p>K1001 (H 200cm)</p> 	<p>K1101 (H 201cm)</p> 	<p>K1101 (H 201cm)</p> 	<p>K1101 (H 201cm)</p> 	<p>K3001 (H 201cm)</p> 	<p>K3001 (H 201cm)</p> 	<p>K3101 (H 202cm)</p> 	<p>K3101 (H 202cm)</p> 
<p>K1131 (H 57cm)</p> 	<p>K1131 (H 57cm)</p> 	<p>K1131 (H 57cm)</p> 	<p>K1131 (H 57cm)</p> 	<p>K2131 (H 20cm)</p> 	<p>K2131 (H 20cm)</p> 	<p>K2131 (H 20cm)</p> 	<p>K2131 (H 20cm)</p> 

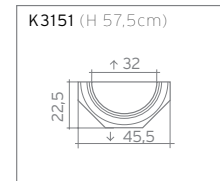
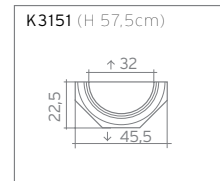
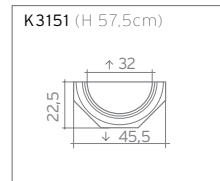
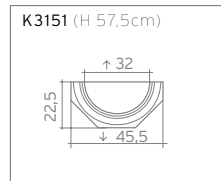
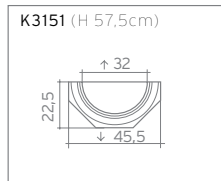
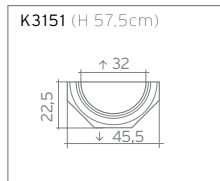
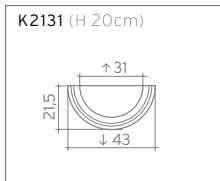
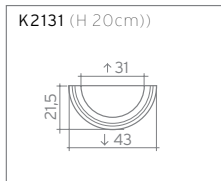
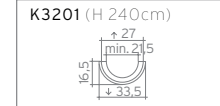
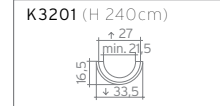
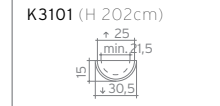
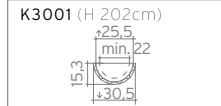
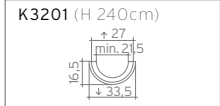
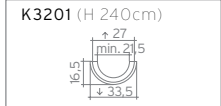
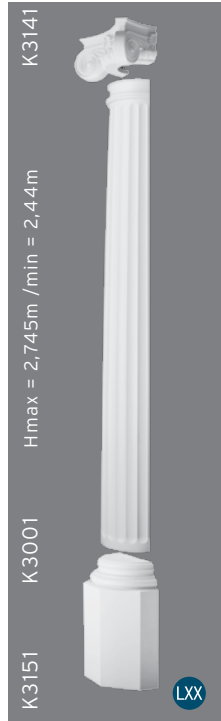
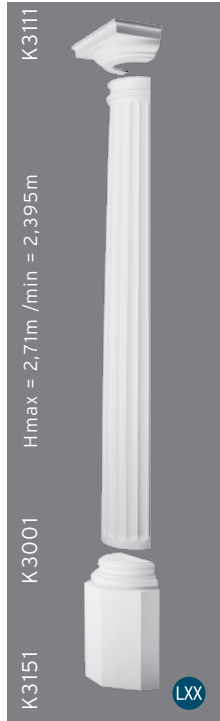
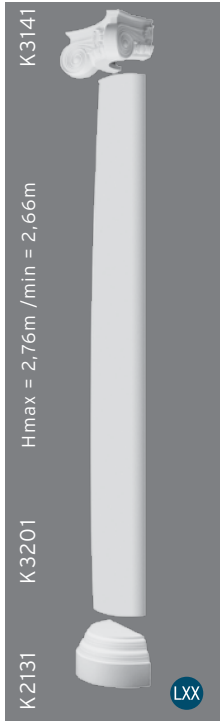
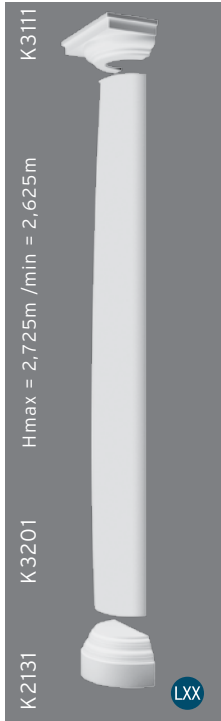
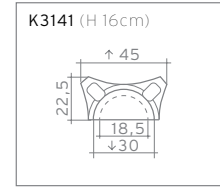
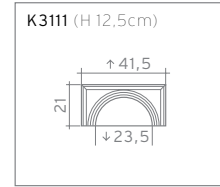
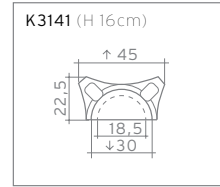
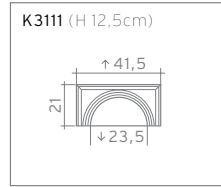
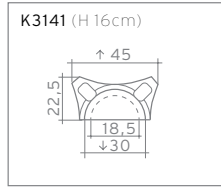
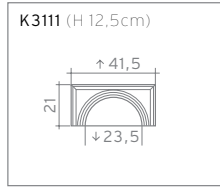
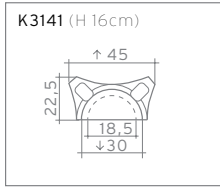
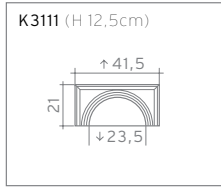

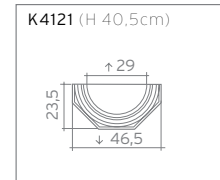
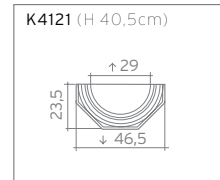
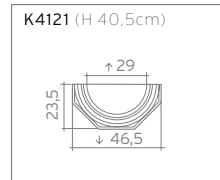
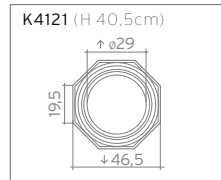
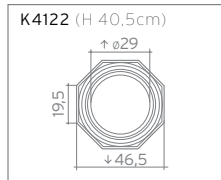
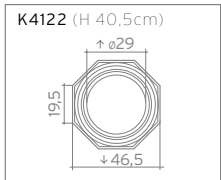
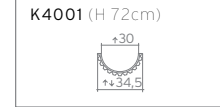
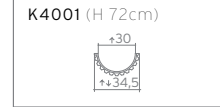
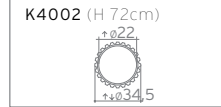
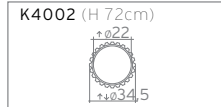
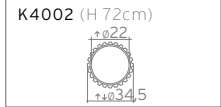
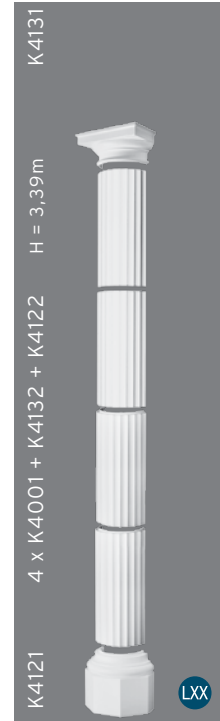
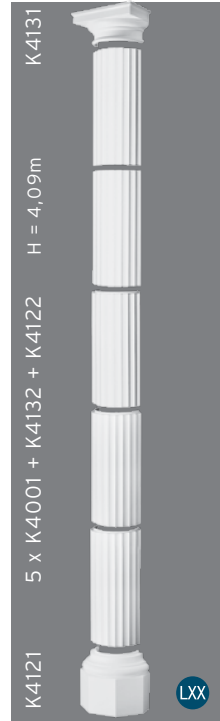
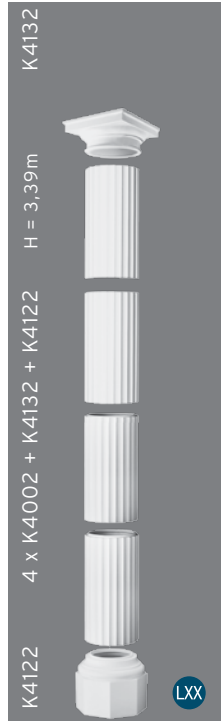
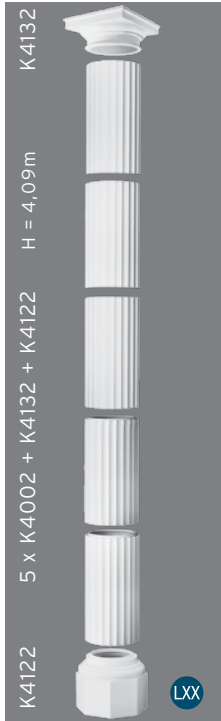
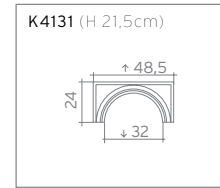
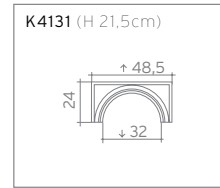
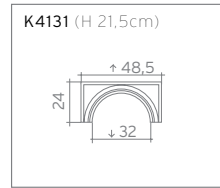
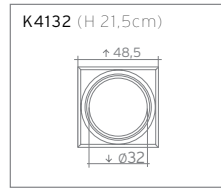
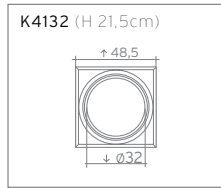
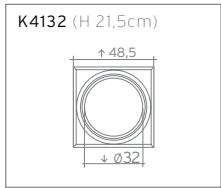



NL

De Orac verlichtingselementen werden volgens de hoogste standaarden op maat van de Orac profielen ontwikkeld om een optimaal lichteffect te creëren en een volledige veiligheid te garanderen. Gelieve bij gebruik van niet-Orac verlichtingssystemen rekening te houden met alle voorgeschreven richtlijnen om zo de veiligheid te waarborgen.

FR

Développés selon les normes les plus strictes, les éléments d'éclairage Orac ont été conçus spécialement pour les moulures Orac afin de garantir un effet lumineux optimal et une sécurité totale. Si vous utilisez des systèmes d'éclairage non Orac, veuillez tenir compte des prescriptions en vue de garantir la sécurité.

EN

The Orac lighting elements have been developed in accordance with the highest standards to fit the Orac profiles to create an optimal light effect and guarantee complete safety. When using non-Orac lighting systems, please observe all of the directives to ensure that safety is guaranteed.

DE

Die Orac-Beleuchtungselemente wurden den höchsten Standards entsprechend nach Maß der Orac-Profilen entwickelt, um einen optimalen Lichteffect zu erzeugen und eine uneingeschränkte Sicherheit zu garantieren. Bitte berücksichtigen Sie bei der Anwendung von Nicht-Orac-Beleuchtungssystemen sämtliche Vorschriften des Herstellers, um die Sicherheit zu gewährleisten.

ES

Cumpliendo la normativa vigente mas estricta, los sistemas de iluminación de Orac Decor han sido concebidos especialmente para las cornisas de Orac Decor con la finalidad de garantizar un efecto luminoso perfecto con la máxima seguridad. Si no se utilizan los sistemas de iluminación de Orac Decor, por favor, revisar bien las normas de seguridad del sistema empleado.

IL000-001

5x plexi cover voor C357, L 100cm
5x couvertures en plexi pour C357, L 100cm
5 x plexi cover for C357, L 100cm
5 x Plexi Abdeckung für C357, L 100cm
5 x plexiglas para C357, L 100cm

IL000-002

5x plexi cover voor C358, L 100cm
5x couvertures en plexi pour C358, L 100cm
5 x plexi cover for C358, L 100cm
5 x Plexi Abdeckung für C358, L 100cm
5 x plexiglas para C358, L 100cm



C901

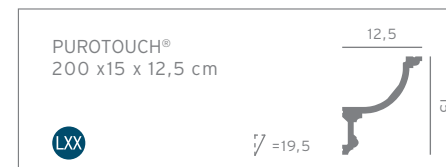

C900

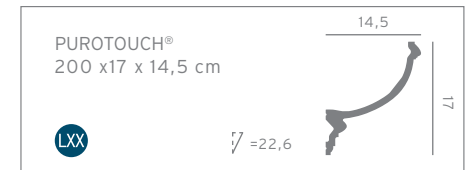

C902

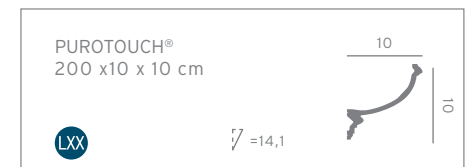

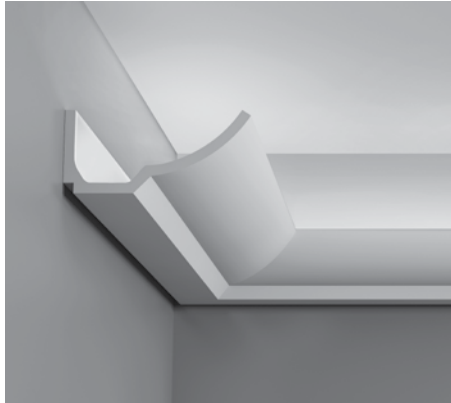

C351 - Designed by Jacques Vergracht

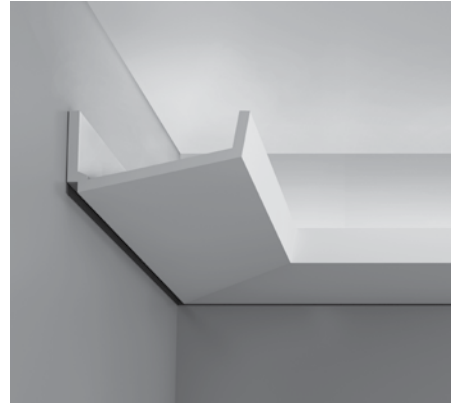
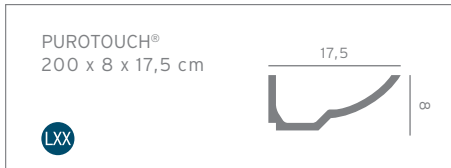

C352 - Designed by Jacques Vergracht

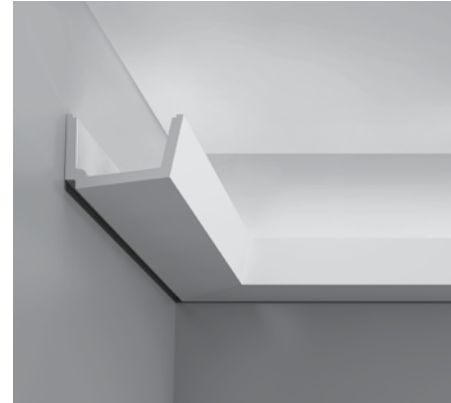
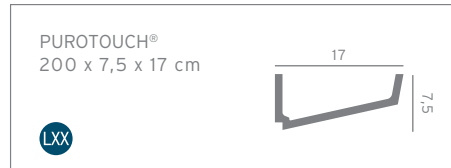

C357 - Designed by Jacques Vergracht

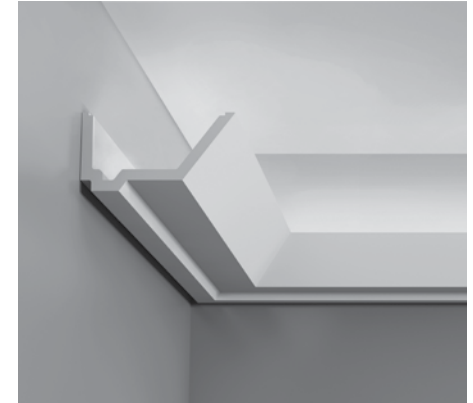
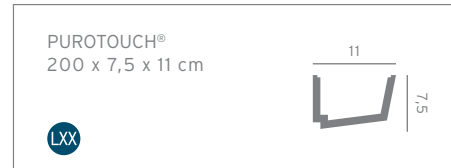

C358 - Designed by Jacques Vergracht

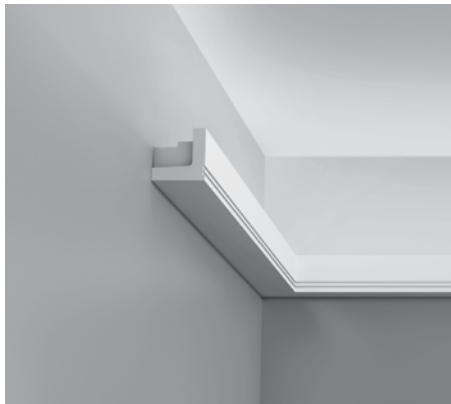

C361 - Designed by Pierre Daems

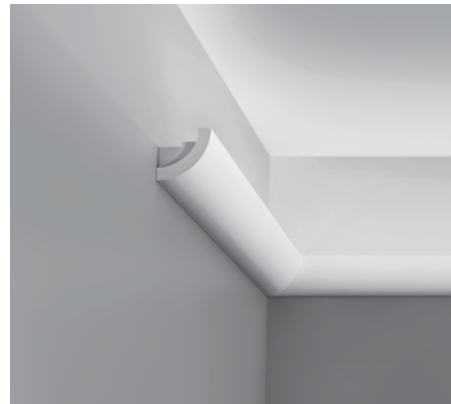
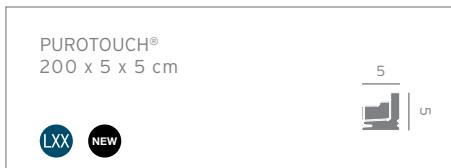

C362 - Designed by Pierre Daems

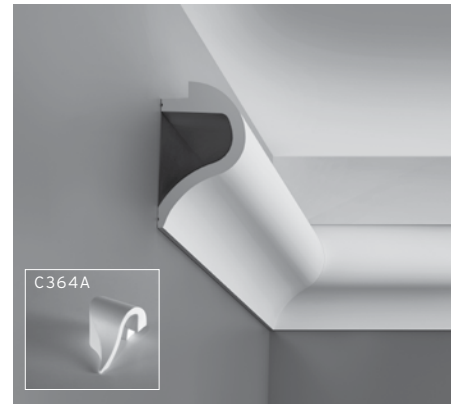
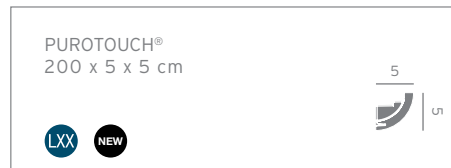

C364 - Designed by Pierre Daems

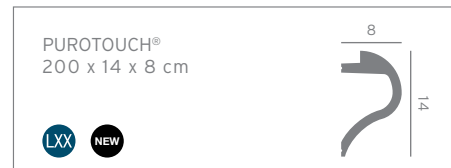

C363 - Designed by Pierre Daems

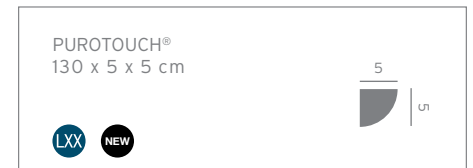



led bars

26 cm 

114,5 cm 

	LOW LUMEN LED BAR	HIGH LUMEN LED BAR
IP CLASS	IP50	IP50
VOLTAGE	24 V	24 V
COLOUR TEMPERATURE	WARM WHITE 2700 - 2900K	WARM WHITE 2700 - 2900K
LIGHT OUTPUT / METER	+/- 100 Lm/M	+/- 500 Lm/M
CRI	80	80
LIFE SPAN (AVGE LUMEN MAINTENANCE)	30 000 HOURS	30 000 HOURS
POWER	+/- 4 W/M	+/- 10,5 W/M

-  MAXIMUM LENGTH OF LED BARS CONNECTED TO A DRIVER (60 W)
-  MAXIMUM CABLE LENGTH FROM DRIVER TO LED BAR CONNECTOR

12 M

6 M

5 M

5 M

led connecting cable / led driver



IL004-003 Waterproof convertor for IL004 (60W) - 15x6,8x5 cm

IP CLASS	IP67
POWER	60 W
INPUT VOLTAGE	240 VAC, MAX. 300 MA
OUTPUT	24 VDC, MAX. 2500 MA



IL004-001 + IL004-002

IL004-001 - 26x2x1,5 cm
IL004-002 - 114,5x2x1,5 cm

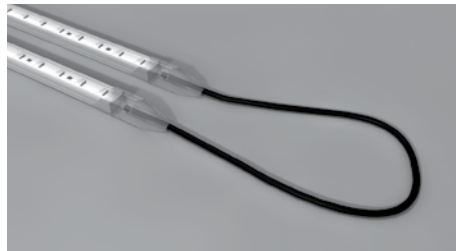

IL004-004

IL004-004 - 12,5 cm



IL004-003 + IL004-005

IL004-005 - 100 cm

T5 tube



	T5 TUBE 1X14W	T5 TUBE 1X28W
IP CLASS	IP20	IP20
VOLTAGE	230 V	230 V
COLOUR TEMPERATURE	WARM WHITE 2700K	WARM WHITE 2700K
LIGHT OUTPUT / METER	1350 Lm/M	2900 Lm/M
POWER	14 W	28 W
LIFE SPAN	15 000 HOURS	15 000 HOURS
⚠️ MAXIMUM QUANTITY OF T5 FIXTURES TO BE CONNECTED	12	12

T5 tube power feed



T5 TUBE 1X14W

IL002-001
T5 tube fixture incl. T5 tube HE 59 cm

T5 TUBE 1X28W

IL002-002
T5 tube fixture incl. T5 tube HE 119 cm

IL002-003 L 180CM



T5 tube (14W + 28W) + IL002-003

T5 tube 14W - 59 cm

T5 tube 28W - 119 cm

IL002-003 - 180 cm



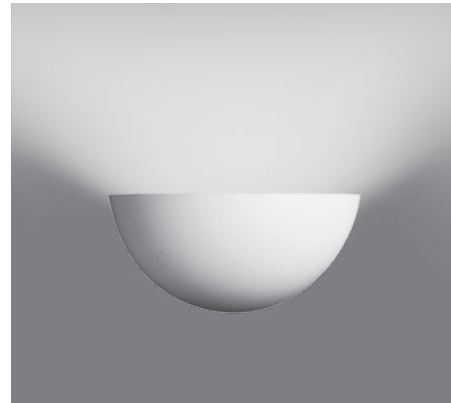
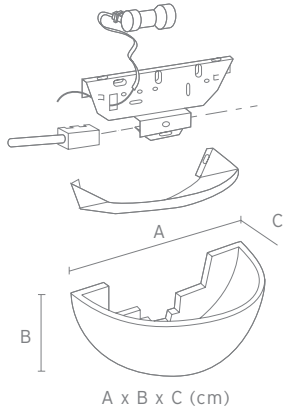

L504

DUROPOLYMER®
30,5 x 15 x 15cm

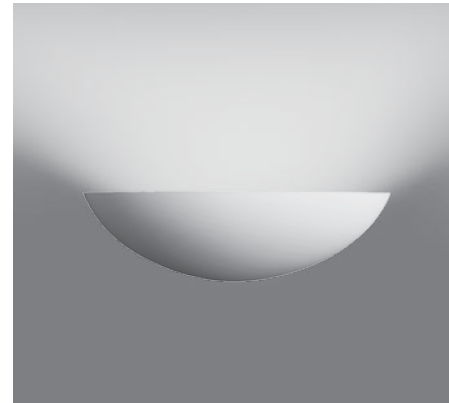

L505

DUROPOLYMER®
41 x 11,5 x 16,5 cm

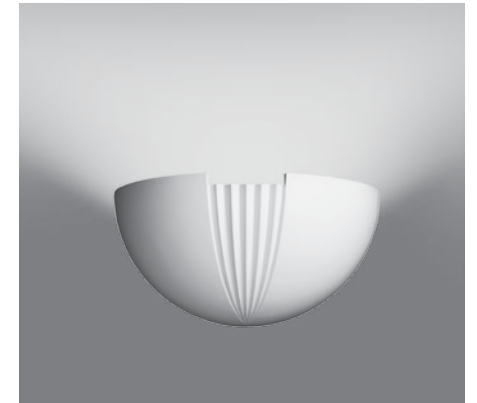

L509

DUROPOLYMER®
29 x 17 x 14,5 cm

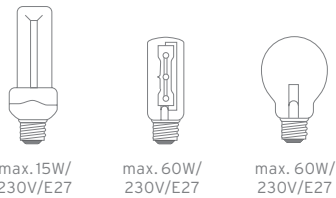

L512

DUROPOLYMER®
30,5 x 12,5 x 15,5 cm

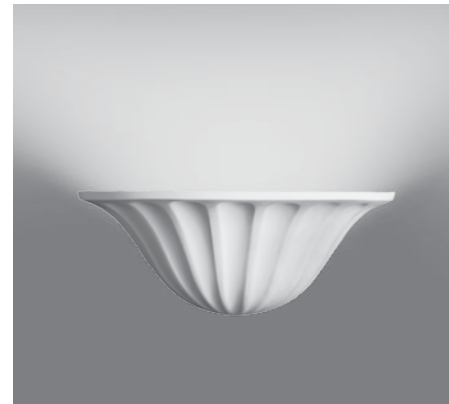

L506

DUROPOLYMER®
39 x 15,5 x 19 cm



L501

DUROPOLYMER®
35 x 22 x 16 cm



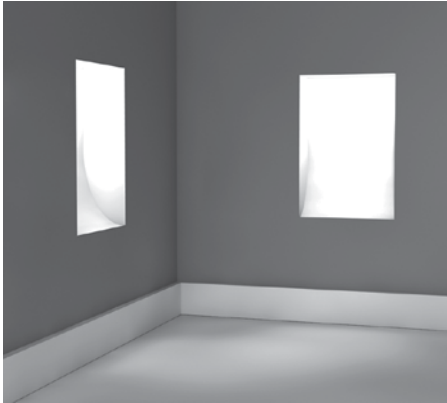

L600-001 XINNIX

19,5 x 8,5 x 34 cm

Inbouwarmatuur voor spaarlamp
 (18W - G24 - q2)
 Armature encastrable pour lampe économique
 (18W - G24 - q2)
Recessed fixture for energy saving lamp
 (18W - G24 - q2)
Einbauarmatur für Sparlampen
 (18W - G24 - q2)
Aplique para encastrar en la pared para lámpara de bajo consumo
 (18W - G24 - q2)

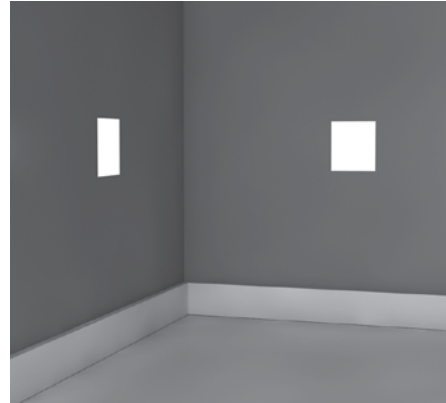

L601-001 XINNIX

10 x 9 x 10 cm

Inbouwarmatuur voor MycroLynx F7W
 (wit & kleur) of MycroLynx LED (wit & kleur)
Luminaire encastré pour MycroLynx F7W
 (en blanc et en couleur) ou MycroLynx LED
 (en blanc et en couleur)
Recessed fixture for MycroLynx F7W
 (white & color) or MycroLynx LED (white & color)
Einbauarmatur für MycroLynx F7W
 (weiss oder in Farbe) oder MycroLynx LED
 (weiss oder in Farbe)
Aplique para encastrar en la pared para lámpara MycroLynx F7W
 (blanco o de color) o LED MycroLynx (blanco o de color)



ILO03-011 LED INSERT

4 x 0,9 x 4,6 cm

Set van 5 LED's (1 LED = 0,2W)
 + verlengkabels (5x1m)
Het is mogelijk 1 LED lamp te vervangen
 Set de 5 LED's (1 LED = 0,2W)
 + câbles d'extension (5x1m)
 Possibilité de remplacer une lampe LED
Set of 5 LED's (1 LED = 0,2W)
 + 5 extension cables (5x1m)
Possible to replace a single LED lamp
 Set mit 5 LED's (1 LED = 0,2W)
 + Verlängerungskabel (5x1m)
 Wechsel der LED-Lampen möglich
Conjunto de 5 LED's (1 LED = 0,2W)
 + cables de extensión (5x1m)
 Posibilidad de cambiar una lámpara LED

ILO03-012 TRANSFO

6 x 3,5 x 2 cm

Transformator max. 20 lampjes
Convertisseur de puissance max. 20 lampes
Converter max. 20 lamps
Trafo für max. 20 Lampen
Transformador max. 20 lámparas

XINNIX: Lampjes worden niet door ORAC verkocht / Les ampoules ne sont pas fournies par ORAC / Lightbulbs not supplied by Orac / Lampen werden von Orac nicht mitgeliefert / Las lámparas no son fabricadas por Orac

NL
Lijmen

BINNEN, POREUZE EN DROGE ONDERGRONDEN

→

Lijmen op wanden en plafonds

+

Naden

Voor Basixx: gebruik DecoFix Pro voor de naden

BUITEN, NIET-POREUZE EN VOCHTIGE ONDERGRONDEN

→

Lijmen op wanden en plafonds

+

Naden

Voor gebruik voor de naden

VOLLEDIGE GARANTIE ENKEL BIJ GEBRUIK VAN DECOFIX

	DecoFix Pro FDP500 310ml > 7 tot 8m FDP600 4200ml > 65 tot 110m	<ul style="list-style-type: none"> • Sterke acryllijm op waterbasis • Langdurende verbinding tussen profielen en muur en/of plafond • Voor binnentoepassingen op poreuze ondergronden (niet in vochtige ruimtes en buiten) • Verwijder met een vochtige spons of doek • Vorstvrij bewaren
	DecoFix Extra FX200 310ml > min. 80m FX210 80ml > min. 20m	<ul style="list-style-type: none"> • Lijm op polyurethaanbasis • Voor naadverbindingen tussen profielen • Verwijder de overtollige lijm vóór uitharding (herhaal na max. 1 uur en na 2 tot 3 uur) • Maak schoon met aceton of synthetische verdunner • Overschilderbaar na 24 uur • Hoe hoger de vochtigheidsgraad, hoe sneller de droogtijd
	DecoFix Hydro FDP700 290 ml > 7 tot 8 m	<ul style="list-style-type: none"> • Extra sterke MS-polymeerlijm • Voor buitentoepassingen, in vochtige ruimtes en op niet-poreuze ondergronden (tegels, glas, ...) • Verwijder met een zeepoplossing

FR
Colles

SURFACES POREUSES, PIÈCES NON HUMIDES

→

Collage sur mur et plafond

+

Joints

Pour Basixx utilisez DecoFix Pro pour les joints

ENVIRONNEMENT HUMIDE, SURFACES NON POREUSES, POSE À L'EXTÉRIEUR

→

Collage sur mur et plafond

+

Joints

Pour Basixx utilisez DecoFix Pro pour les joints

GARANTIE TOTALE UNIQUEMENT AVEC COLLE DECOFIX

	DecoFix Pro FDP500 310ml > 7 à 8m FDP600 4200ml > 65 à 110m	<ul style="list-style-type: none"> • Colle forte à base d'eau et d'acrylique • Joint longue durée entre les moulures et le mur et/ou le plafond • Pour les applications intérieures et les surfaces poreuses (hors environnement humide ou extérieur) • Retirez à l'aide d'une éponge ou d'un chiffon humide • Doit être conservée à l'abri du gel
	DecoFix Extra FX200 310ml > min. 80m FX210 80ml > min. 20m	<ul style="list-style-type: none"> • Colle polyuréthane • Pour l'assemblage des joints entre les moulures • Éliminez les excès de colle avant le durcissement (1 heure max. et recommencez après 2-3 heures) • Nettoyez avec de l'acétone ou un diluant synthétique • Peut être peint après 24 h • Humidité est importante
	DecoFix Hydro FDP700 290 ml > 7 à 8 m	<ul style="list-style-type: none"> • Colle au MS polymère extra forte • Pour les applications extérieures, les environnements humides, les surfaces non poreuses (carrelage, verre, etc.) • Enlevez à l'aide d'une solution savonneuse

EN
Glues

INTERIOR, POROUS AND DRY SURFACE

→

Gluing on wall and ceiling

+

Joints

For Basixx use DecoFix Pro for joints

EXTERIOR, NON-POROUS AND HUMID SURFACE

→

Gluing on wall and ceiling

+

Joints

For Basixx use DecoFix Pro for joints

ONLY FULL GUARANTEE WITH DECOFIX

	DecoFix Pro FDP500 310ml > 7 to 8m FDP600 4200ml > 65 to 110m	<ul style="list-style-type: none"> • Strong, water-based acrylic glue • Long-lasting seal between mouldings and the wall and/or ceiling • For interior applications and porous surfaces (not for humid spaces or outside) • Remove with humid sponge or cloth • Should be kept frost free
	DecoFix Extra FX200 310ml > min. 80m FX210 80ml > min. 20m	<ul style="list-style-type: none"> • Polyurethane-based glue • Seam joints between the mouldings • Remove excess glue before hardening (max. 1 hour and repeat after 2-3 hours) • Clean with acetone or Synth Thinner • Can be painted after 24 hrs • The more humidity, the faster the drying time
	DecoFix Hydro FDP700 290 ml > 7 to 8 m	<ul style="list-style-type: none"> • Extra strong MS polymer glue • For exterior applications, damp environments, non-porous surfaces (tiles, glass, ...) • Remove with soap solution

DE
Kleber

INNEN, PORÖSE/SAUGFÄHIGER UND TROCKENE UNTERGRÜNDE

Kleben an Wand und Decke

Stoßstellen

Für Basixx Verwenden Sie DecoFix Pro für die Stoßstellen

AUSSEN, NICHT-PORÖSER/SAUGFÄHIGER UNTERGRUND UND FEUCHTRÄUME

Kleben an Wand und Decke

Stoßstellen

Für Basixx Verwenden Sie DecoFix Pro für die Stoßstellen

VOLLSTÄNDIGE GARANTIE NUR BEI DER VERWENDUNG VON DECOFIX

	DecoFix Pro FDP500 310ml > 7 bis 8m FDP600 4200ml > 65 bis 110m	<ul style="list-style-type: none"> • Starker, wasserbasierter Acrylkleber • Langhaltende Verbindung zwischen Profilen und Wand und/oder Decke • Für Innenanwendungen auf porösen/saugfähigen Untergründen (nicht in Feuchträumen und Außenbereichen) • Mit wenig feuchtem Schwamm oder Tuch entfernen • Frostfrei lagern
	DecoFix Extra FX200 310ml > min. 80m FX210 80ml > min. 20m	<ul style="list-style-type: none"> • Polyurethanbasierter Kleber • Für Nahtverbindungen zwischen Profilen • Überschüssigen Kleber vor dem Aushärten entfernen (nach 1 Std und nach 2 - 3 Std wiederholen) • Mit Aceton oder synthetischem Verdüner reinigen • nach 24 Std überstrichbar • Je höher die Luftfeuchtigkeit, desto kürzer die Trockenzeit
	DecoFix Hydro FDP700 290 ml > 7 bis 8 m	<ul style="list-style-type: none"> • Besonders starker MS-Polymerkleber • Für Außenanwendungen, in Feuchträumen und auf nicht porösem/saugfähigem Untergrund (Fliesen, Glas,...) • Mit Seifenlösung entfernen

ES
Colas

INTERIOR, SUPERFICIES SECAS Y POROSAS

Encolar al techo y la pared

Uniones entre piezas

Para Basixx utilice DecoFix Pro para las uniones entre piezas

EXTERIOR, AMBIENTES HÚMEDOS E INSTALACIONES EN SUPERFICIES NO POROSAS

Encolar al techo y la pared

Uniones entre piezas

Para Basixx utilice DecoFix Pro para las uniones entre piezas

GARANTÍA COMPLETA SÓLO SI SE UTILIZA DECOFIX

	DecoFix Pro FDP500 310ml > 7 a 8m FDP600 4200ml	<ul style="list-style-type: none"> • Cola / masilla • Fuerte, cola acrílica con base de agua • Larga adherencia con nuestras masillas en techos y paredes • Para aplicaciones al interior y superficies porosas no para espacio húmedos (o aplicaciones al exterior). • Eliminar con una esponja o paño húmedo • Debe guardarse en un ambiente seco
	DecoFix Extra FX200 310ml > min. 80m FX210 80ml > min. 20m	<ul style="list-style-type: none"> • Cola sólo uniones (Basixx no) • Cola a base de Poliuretano • Sellar las uniones entre las molduras • Eliminar cola excesiva antes de endurecer (max. 1 hora y repetir 2-3 horas después) • Limpiar con acetona o disolvente sintético • Puede pintarse después de 24 horas • Cuanta más humedad, más rápida la duración de secado
	DecoFix Hydro FDP700 290 ml > 7 a 8 m	<ul style="list-style-type: none"> • Cola / masilla • Extra fuerte, cola a base de Poliuretano • Para aplicaciones al exterior, lugares húmedos, superficies no porosas (cerámica, vidrio,...) • Eliminar con agua y jabón



FB10
A: max. 27,5 cm
B: max. 22 cm

FB300
A: max. 29,7 cm
B: max. 29,1 cm

FB13
A: max. 12,5 cm
B: max. 15,5 cm

FB14

FDP100

FX210 FX200

FDP600

FDP500

FDP700

FB15

Inside corner | Binnenhoek | Coin intérieur | Innenecke | Esquina interna

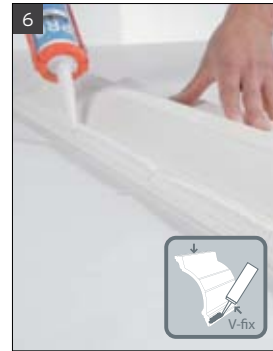
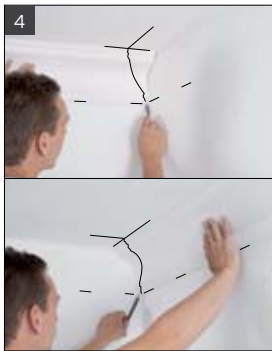

Outside corner | Buitenhoek
Coin extérieur | Aussenecke
Esquina externa

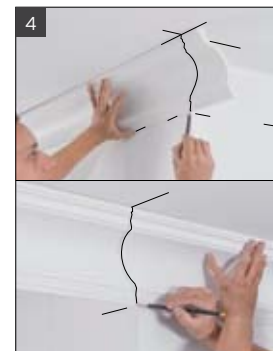

Stop mitre | Stopverstek
Couper en onglets |
Auf Gehrung schneiden
Ingletadora



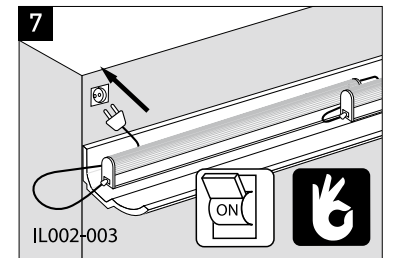
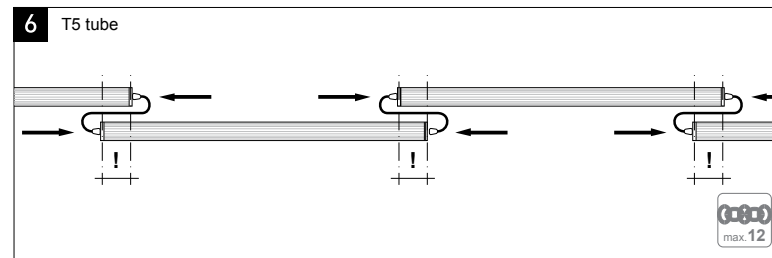
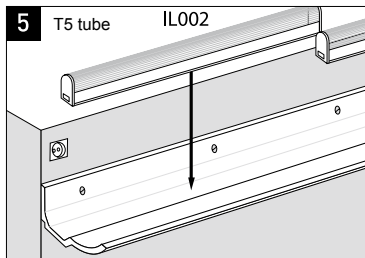
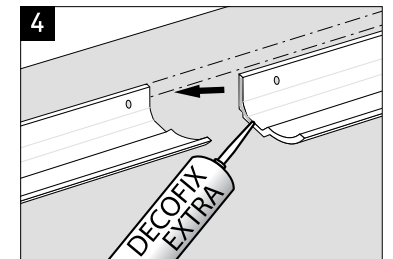
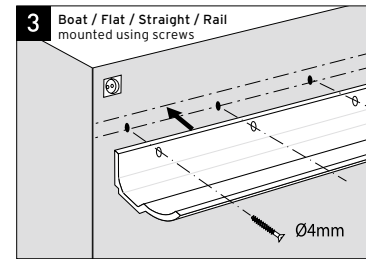
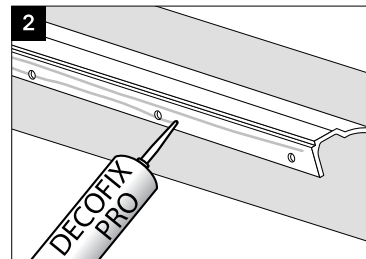
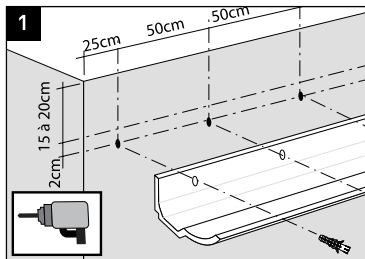
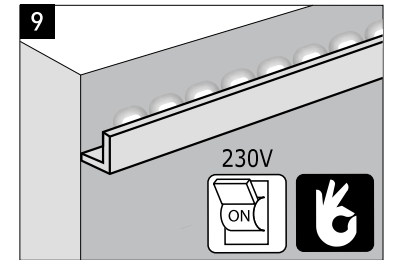
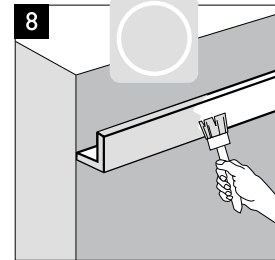
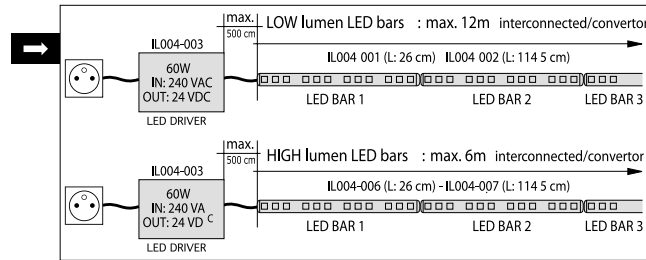
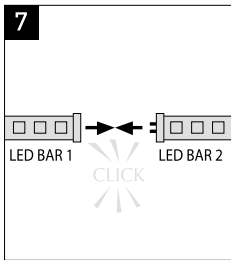
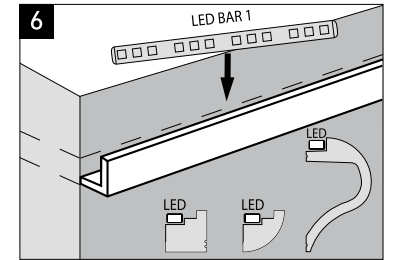
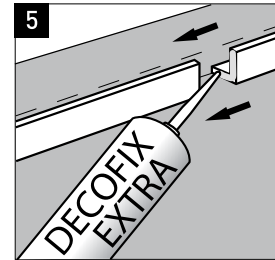
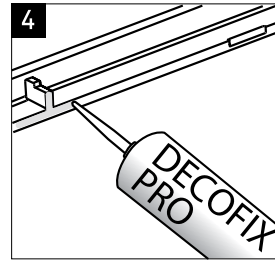
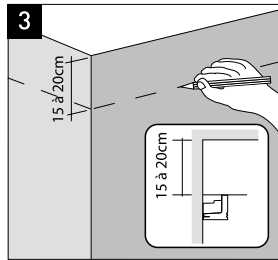
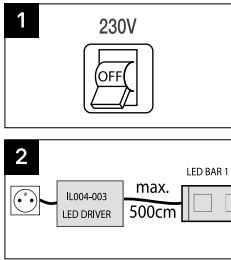



ORAC DECOR XXL 1 CASE
MS046-001 XX AXX BXX



ORAC DECOR XXL 2 CASE
MS046-002 LXX AXX



ORAC DECOR XXL 3 CASE
MS046-003 LXX



ORAC DECOR MEDIUM 1 CASE
A45-001 AXX BXX



ORAC DECOR MEDIUM 2 CASE
A45-002 AXX XX



ORAC DECOR
DISPLAY LUXUS Collection MD016-001

ALSO AVAILABLE:
DISPLAY AXXENT Collection MD016-002
DISPLAY BASIXX Collection MD017-002



ORAC DECOR SKIRTING BOX
MS008-001



ORAC DECOR ARCHIBOX
MS010-002



ORAC DECOR WALL + SAMPLE SLIDE SYSTEM
MD013-405

'Also available without sample slide system' MD013-005



ORAC DECOR CORNER - WITHOUT SAMPLE SLIDE SYSTEM
MD013-006

'Also available with sample slides system' MD013-406



ORAC DECOR TOWER MEDIUM
MD013-019

NL

BUITENTOEPASSINGEN

Zowel de Luxxus als de Axxent producten zijn geschikt voor buiten en in vochtige ruimtes. Voor de verlijming gaat u hetzelfde te werk als bij binnentoepassingen, maar u vervangt de DecoFix Pro door de DecoFix Hydro. Deze producten dienen met een kwalitatieve buitenverf overschilderd te worden.

BINNENINSTALLATIE HARDE KROONLIJSTEN

Garantievoorwaarden gelden enkel bij volledige naleving van de installatieinstructies.

GARANTIE

ORAC DECOR® ornamenten zijn onbreekbaar, licht en gemakkelijk te installeren. Ze worden verwerkt als licht hout en afgewerkt met kwaliteitsverven. Controleer de afmetingen van de ornamenten op de werkplaats vooraleer te installeren. Maatwijzigingen en afwijkingen ten opzichte van deze catalogus voorbehouden. Contacteer ons gerust voor verdere inlichtingen. Alle technische informatie vindt u terug op www.oracdecor.com. Garantievoorwaarden gelden enkel bij volledige naleving van deze instructies.

BRANDVOORSCHRIFTEN

In veel interieurs of projecten zijn strikte brandvoorschriften opgelegd. Orac heeft daarvoor verschillende oplossingen, afhankelijk van het land en zijn reglementeringen. Contacteer ons 'engineering department' voor een specifiek verzoek.

FR

APPLICATIONS EXTÉRIEURES

Tant les produits Luxxus que les produits Axxent conviennent pour l'extérieur et les endroits humides. Pour encoller ces produits, vous procédez de la même façon que pour les applications à l'intérieur, mais vous remplacez la DecoFix Pro par la DecoFix Hydro. Ces produits doivent être parachevés avec une peinture spéciale pour extérieur.

INSTALLATION DE CORNICHES DURES DANS UN INTÉRIEUR

Les conditions de garantie sont uniquement valables en cas d'observation complète des instructions de pose.

GARANTIE

Les ornements ORAC DECOR® sont incassables, légers et faciles à installer. Ils sont utilisés comme du bois léger et parachevés avec des peintures de qualité. Contrôlez les dimensions des ornements dans la pièce où ils doivent être installés, avant de procéder à l'installation, sous réserve de modifications et de discordances avec les mesures indiquées dans ce catalogue. N'hésitez pas à nous contacter pour obtenir de plus amples informations. Vous trouverez toutes les informations techniques sur www.oracdecor.com. Les conditions de garantie ne sont d'application que si ces instructions ont été suivies à la lettre.

NORMES ANTI-INCENDIE

Pour beaucoup d'intérieurs et de projets, les exigences en terme de prévention incendie sont très strictes. C'est pour cette raison qu'Orac propose quelques produits répondant aux standards anti-feu et élabore des solutions adaptées aux exigences de votre projet. Contactez nous pour plus d'information.

EN

EXTERIOR APPLICATIONS

All Luxxus as well as the Axxent products can be used for exterior applications and in damp environments. To glue the ornaments, you proceed exactly as for interior applications, but you replace the DecoFix Pro adhesive product with DecoFix Hydro. The products have to be covered with a special coating for outside use.

INTERIOR INSTALLATION OF RIGID CORNICE MOULDINGS

Guarantee terms and conditions apply if provided installation instructions have been followed to the letter.

GUARANTEE

ORAC DECOR® ornaments are unbreakable, light and easy to install. They are processed in the same way as light wood and finished with a quality primer. You will find all the technical information on our website www.oracdecor.com. Guarantee terms and conditions apply if provided instructions have been followed to the letter. Check the measurements of the ornaments on the premises before you start installing them, there may be some discrepancies in sizes or/and shapes against those stated in the catalogue. Do not hesitate to call for any further information you may require.

FIRE RETARDANT STANDARDS

In many interiors and projects strict fire regulations are imposed. Therefore, ORAC has implemented a number of solutions depending on the country and its regulations. Please contact our engineering department for more detailed requests.

DE

INNENMONTAGE VON ECKLEISTEN

Die Garantie ist nur gültig bei einer Installation gemäß der Montagehinweise.

AUßENVERARBEITUNG

Alle Luxus und Axxent Artikel eignen sich, unter Einhaltung der Verarbeitungsrichtlinien, für die Verwendung im Außenbereich und Feuchträumen (Schwimmbad, Sauna, etc.). Für Außenarbeiten und Feuchträume zur Montage DecoFix Hydro anstelle von DecoFix Pro verwenden. Die Produkte müssen mit einer speziellen Fassadenfarbe versehen werden.

GARANTIE

Alle ORAC DECOR®-Profile sind im Gegensatz zu Stuck aus Gips oder Holz leicht, sehr widerstands-fähig und einfach zu installieren. Qualitätsfarben, gleich ob Lack, Dispersion oder Lasuren, werden hervorragend angenommen. Alle Technische Information finden Sie auf www.oracdecor.com. Die Garantie ist nur gültig bei einer Installation gemäß der Montagehinweise. Kontrollieren Sie vor der Montage die Maße und Beschaffenheit der Ware. Wir behalten uns das Recht vor, Produktänderungen, die ausschließlich der Verbesserung des Artikels dienen, den Vertragszweck nicht gefährden und zumutbar sind, ohne Vorankündigung durchzuführen. Wir geben Ihnen gerne telefonisch weitere Auskünfte.

BRANDVORSCHRIFTEN

Für viele Interieure und Projekte gelten sehr strenge Richtlinien. Folglich hat Orac, unter Berücksichtigung der jeweils gültigen Normen in unseren Exportländern, eine Reihe von Lösungen ausgearbeitet. Für ausführliche Informationen kontaktieren Sie uns

ES

INSTALACIÓN DE CORNISAS RIGIDAS EN EL INTERIOR

La garantía será efectiva siempre que se sigan las instrucciones de montaje.

APLICACIONES PARA EXTERIOR

Toda la gama Luxus y Axxent pueden ser utilizadas en el exterior o en ambientes húmedos. Para encolar los productos se hará de la misma manera que en el interior pero sustituyendo la cola DecoFix Pro por la DecoFix Hydro. Los productos tienen que ser pintados con pintura para exterior.

GARANTÍA Y NORMAS IGNIFUGAS

Los ornamentos ORAC DECOR® son resistentes, ligeros y fáciles de instalar. Puede encontrar toda la información técnica en www.oracdecor.com. La garantía no será efectiva si no se siguen las instrucciones de instalación.

Verificar las medidas de los ornamentos antes de empezar la instalación. Puede haber alguna diferencia de tamaño o forma respecto al catálogo. No duden en contactarnos para más información.

NORMAS IGNIFUGAS

Para muchos proyectos de interior la normativa anti-fuego son muy estrictas. Por este motivo Orac propone varias soluciones en función de las exigencias de cada país. Por favor, no dude en contactarnos para ofrecerle una información más detallada.



DX162-2300









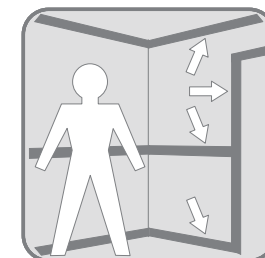
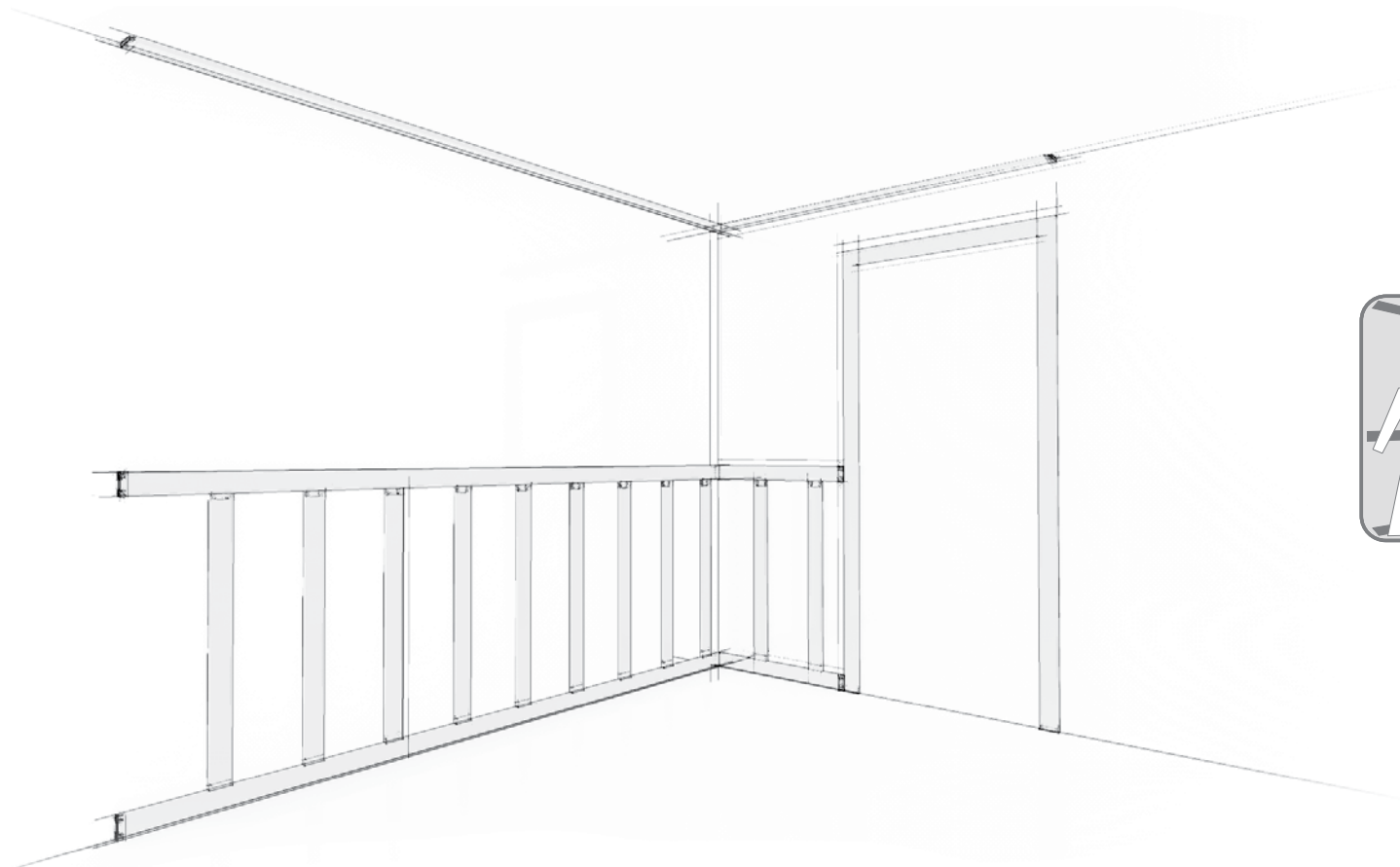

















DX162-2300



DX162-2300



De nieuwe Axxent producten zijn multifunctioneel en kunnen voor verschillende toepassingen gebruikt worden.
 Les nouveaux produits Axxent sont multifonctionnels et peuvent être utilisés pour plusieurs applications.
 The new Axxent profiles are multifunctional and can be used for a variety of applications.
 Die neuen Axxent Leisten sind multifunktional und können in den unterschiedlichsten Bereichen eingesetzt werden.
 Las nuevas molduras de Orac Axxent son multifuncionales y pueden ser utilizadas para varias aplicaciones.

 <p>Klasse I met aarding - Classe I avec prise de terre Safety Class I with earthing - Clase I con tierra Schutzklasse I erfordert einer Schutzleiteranschluß</p>	 <p>Spaarlamp niet inbegrepen - Lampe économique non incluse Energy saving lamp not included - Exklusiv Sparlampe Lámpara económica no incluida</p>	 <p>Max. aantal armaturen in één lijn - Max. nombre d'armatures en ligne Max. number of fixtures interconnected - Max. Anzahl Verbindungen in Reihe - Número máximo de lámparas interrelacionadas</p>
 <p>Klasse II met dubbele isolatie - Classe II avec double isolation Safety Class II double isolation - Clase II doble aislamiento Schutzklasse II doppelte Isolierung</p>	 <p>MycroLynx lamp niet inbegrepen - Lampe MycroLynx non incluse MycroLynx lamp not included - Exklusiv MycroLynx Lampe Lámpara MycroLynx no incluida</p>	 <p>Budgetvriendelijk - Prix économique Budget friendly - Preiswert Precio económico</p>
 <p>Klasse 3 laagspanning - Classe 3 basse tension Safety Class III low voltage - Clase III baja tensión Schutzklasse III Sicherheitskleinspannung</p>	 <p>Niet-dimbaar - Sans variateur Not dimmable - Nicht dimmbar Sin variador</p>	 <p>Laag energieverbruik - Basse consommation d'énergie Low energy use - Niedriger Energieverbrauch Consumo mínimo de energía</p>
 <p>12V gelijkspanning - 12V tension continue - 12V constant tension 12V Gleichstrom 12V - 12V tensión continua</p>	 <p>Dimbaar - Avec variateur Dimmable - Dimmbar Con variador</p>	 <p>Makkelijk te installeren - Installation très simple Easy to install - Einfach zu installieren Fácil de instalar</p>
 <p>230V 240V 230 - 240V 50Hz</p>	 <p>Dimbare elektronische ballast - Ballast électronique avec variateur Electronic dimmable ballast - Elektronisch dimmbares Vorschaltgerät Balastro para variador electrónico</p>	 <p>Geschikt voor directe bevestiging in/op normaal ontvlambare oppervlakten Convient pour un montage direct dans/sur des surfaces inflammables Suitable for direct mounting in/on flammable surfaces Geeignet für direkte Montage in/auf entflammbare Oberflächen Indicado para instalación directa en superficies inflamables</p>
 <p>Beschermingsindicatie - Indice de protection Protection level - Schutzklasse Nivel de protección</p>	 <p>Kleurtemperatuur lamp - Température de couleur lampe Colour temperature lamp - Farbtemperatur Lampe Vida útil de las lámparas</p>	
 <p>CE norm - CE Norme CE Approval - CE Standard CE Aprobación</p>	 <p>Minimum afstand tot de muur - Distance minimale du mur Minimum distance to wall - Mindestabstand zur Wand Distancia mínima de la pared</p>	
 <p>GS-gekeurde producten - Produits avec GS qualification GS approved products (tested safety) - Geprüfte Sicherheit Productos con GS de cualificación</p>	 <p>Uplighter - Luminosité vers le haut Uplight - Nach oben leuchtend Iluminación hacia arriba</p>	
 <p>Energie efficiëntie kwalificatie - Qualification d'efficacité d'énergie Energy efficiency qualification - Geprüfte Energieeffizienz Cualificación de energía eficiente</p>	 <p>Opbouwarmatuur - Applique murale Mounted fixture - Aufputzleuchte Aplicque para instalación</p>	
 <p>T5 HE G5 lamp inbegrepen - T5 HE G5 lampe incluse T5 HE G5 lamp included - Inklusiv T5 HE G5 Lampe T5 HE G5 lámparas incluida</p>	 <p>Downlighter - Luminosité vers le bas Downlight - Nach unten leuchtend Iluminación hacia abajo</p>	

REGISTERED MODELS:

C351:	000257464-0003	
C352:	000257464-0004	
C353:	000257464-0005	P5051: 000257464-0001
C354:	000257464-0006	P5050: 000257464-0002
C355:	000257464-0007	
C356:	000257464-0008	P8050: 000995576-0003
		P9900: 000995576-0004
C335:	000995576-0001	P9901: 000995576-0005
C336:	001035273-0001	
C990:	000995576-0002	SX156: 000995576-0006

NL				FR				EN			
Brandvoorschriften	112	Panelen	78	Appliques	104	Installation	108	Accessories	107	Mitre box	107
Byblos	76	Pilasters	91	Boîte à onglets	107	LED bars	102	Byblos	76	MycroLynx	105
Consolen	80	Plafonddecoratie	84	Byblos	76	LED insert	105	Capitals (columns)	92-98	Niches	83
DecoFix Extra	106	Plafondtegels	84	Chapiteaux	91-98	Marketing tools	110	Ceiling ornaments	84	Paint	112
DecoFix Hydro	106	Plinten	68	Cheminées décoratives	81	Moulures flexibles	71	Ceiling tiles	84	Panels	78
DecoFix Pro	106	Poluurethaan	38	Cimaises	60-67	Murs courbés	71	Ceiling roses	86-89	Panel mouldings	60-67
Deuromlijstingen	72	Purotouch®	38	Colles d'installation	106	MycroLynx	105	Columns	92-98	Pediments	74
Deurpanelen	78	Ronde muren	71	Colonnes	92-98	Niches	83	Corbels	80	Pilasters	91
Duropolymere®	40	Rozassen > rozetten	86-89	Consignes d'incendie	112	Outils	107	Cornice mouldings	42-58	Polyurethane	38
Flexibele lijsten	71	Schachten	92-98	Colonne segmentée	98	Panneaux	78	Deco elements	82	Purotouch®	38
Garantie	112	Schappen	80	Colonnes	92-98	Panneaux de portes	78	DecoFix Extra	106	Rounded walls	71
Gereedschap	107	Sierelementen	82	Consoles	80	Peinture	112	DecoFix Hydro	106	Safety regulations info	112
Gesegmenteerde zuil	98	Sierschouwen	81	Corbeaux > consoles	80	Pilastres	91	DecoFix Pro	106	Saw	107
Halve zuilen	95-97	Sokkels	92-98	Corniches	42-58	Pistolet à colle	107	Domes	85	Segmented column	98
Indirecte verlichting	101	T5 Tube	103	Coupoles	85	Plinthes	68	Door frames	72	Shelves	80
Installatie	108	Timpaan > fronton	74	Dalles de plafond	84	Poluurethane	38	Door panels	78	Skirting	68
Installatielijm	106	Variomatic	107	DecoFix Extra	106	Purotouch®	38	Duropolymere®	40	Socle	92-98
Kaderlijsten > wandlijsten	60-67	Veiligheidsinformatie	112	DecoFix Hydro	106	Rosaces > rosettes	86-89	Fire retardant standards	112	T5 Tube	103
Kapitelen	91-98	Verf	112	DecoFix Pro	106	Scie	107	Fixtures	104	Variomatic	107
Koepels	85	Verlichting	100-105	Décoration murale	82	Socles	92-98	Flexible mouldings	71	Wall decoration	82
Kolommen > zuilen	92-98	Verstekbak	107	Décoration de plafond	84	T5 Tube	103	Glue	106	Warranty	112
Kraagstuk > console	80	Voetstukken > sokkels	92-98	Demi-Colonnes	95-97	Tympan > fronton	74	Glue pistol	107	Xinnix®	105
Kroonlijsten	42-58	Volle zuilen	92-94	Duropolymere®	40	Variomatic	107	Half Columns	95-97		
LED bars	102	Wandlampen	104	Eclairage	100-105	Xinnix®	105	Lighting	100-105		
LED insert	105	Wandlijsten	60-67	Eclairage indirecte	101			Indirect lighting	101		
Lijmen	106	Xinnix®	105	Eléments décoratifs	82			Installation	108		
Lijmpistool	107	Zaag	107	Encadrements > cimaises	60-67			LED bars	102		
Marketing tools	110	Zuilen	92-98	Encadrements de portes	72			LED insert	105		
Muurdecoratie	82			Etagères	80			Mantel pieces	81		
MycroLynx	105			Garantie	112			Marketing tools	110		
Nissen	83			Information de sécurité	112						

DE		ES	
Armaturen	104	Pedimente	74
Beleuchtung	100-105	Pilaster	91
Brandvorschriften	112	Polyurethan	38
Byblos	76	Purotouch®	38
Deckenzierelemente	84	Rosetten	86-89
Deckenplatten	84	Säge	107
DecoFix Extra	106	Säulen	92-98
DecoFix Hydro	106	Segmentierte Säule	98
DecoFix Pro	106	Schaft	92-98
Dome	85	Sicherheitsinformationen	112
Duropolymers®	40	Sockel	92-98
Eckleisten	42-58	Sockelleisten	68
Farbe	112	T5 Tube	103
Flexible Leisten	71	Türumrandungen	72
Garantie	112	Türpaneelle	78
Gebogene Wände	71	Unterbau > Konsole	92-98
Gehrungslade	107	Variomatic	107
Halbsäulen	95-97	Wandbords	78
Indirekte Beleuchtung	101	Wanddekoration	82
Installation	108	Wand- und Friesleisten	60-67
Kamine	81	Xinnix®	105
Kapitelle	92-98	Zierelemente	82
Kleber	106	Zubehör	107
Klebstoffpistole	107		
Konsolen	80		
LED bars	102		
LED insert	105		
Marketing tools	110		
MycroLynx	105		
Nischen	83		
Paneelle	78		
		Accesorios	107
		Apliques para la pared	104
		Bases	92-98
		Byblos	76
		Capiteles	92-98
		Chimeneas decorativas	81
		Clasificación al fuego	112
		Cola para la instalación	106
		Columns	92-98
		Columns segmentadas	98
		Cornisas	42-58
		Cúpula	85
		DecoFix Extra	106
		DecoFix Hydro	106
		DecoFix Pro	106
		Decoración de paredes	82
		Decoraciones para techo	84
		Duropolymers®	40
		Elementos decorativos	82
		Estanterías	80
		Frontones	74
		Fustes	92-98
		Garantía	112
		Hornacinas	83
		Iluminación	100-105
		Iluminación indirecta	101
		Información de seguridad	112
		Ingletadora	107
		Instalación	108
		LED bars	102
		LED insert	105
		Marcos de puertas	72
		Marketing tools	110
		Medias Columns	95-97
		Ménsulas	80
		Molduras	60-67
		Molduras flexibles	71
		MycroLynx	105
		Paredes redondas	71
		Paneles	78
		Pilastras	91
		Pintura	112
		Pistola para colas	107
		Poliuretano	38
		Purotouch®	38
		Rosetones	86-89
		Sierra	107
		T5 Tube	103
		Variomatic	107
		Xinnix®	105
		Zócalos	68

M

M9010A	77
M9010B	77
M9010C	77
M9010LR	77

N

N403	83
N404	83
N410	83
N503	83
N504	83
N510	83
N520	83

P

P101A	64
P20	64
P20+P101A	64
P201A	64
P21	64
P21+P201A	64
P1020/P1020F	63/64
P2020/P2020F	63/64
P3020/P3020F	63
P4020/P4020F	60
P4020A+P4020	62
P5020/P5020F	61
P5021/P5021F	60
P5050	62
P5051	61
P6020/P6020F	63
P7010/P7010F	64
P7020/P7020F	64
P7030/P7030F	63
P7040/P7040F	63
P7050/P7050F	63
P7060/P7060F	63
P7070/P7070F	61
P7080	64
P801C+P8020	62
P8020/P8020F	60
P8030/P8030F	60
P8030C+P8030	62

P8040/P8040F	62
P8050/P8050F	62
P8060/P8060F	60
P9010/P9010F	61
P9020/P9020F	61
P9040/P9040F	60
P9050/P9050F	60
P9900/P9900F	46/61
P9901/P9901F	47/60
P4020A	62
P5020A	61
P5020B	61
P801C	62
P8030C	62
P8030D	62
PB513	57
PB513A	57
PX102	67
PX103	66
PX103A	67
PX103A+PX103	67
PX113	66
PX114	66
PX116	66
PX117	66
PX120	66
PX120A	67
PX120A+PX120	67
PX131	66
PX144	66
PX164	51/67

R

R07	86
R08	86
R09	86
R10	87
R11	87
R12	87
R13	87
R14	87
R16	88
R17	88
R18	88
R22	88

R23	89
R24	89
R27	89
R28	89
R31	87
R35	86
R38	89
R40	86
R46	88
R50	87
R52	89
R61	87
R64	89
R66	86
R73	89
R74	88
R76	86
R77	88

S

SX104	69
SX105/SX105F	69
SX118/SX118F	69
SX155/SX155F	69
SX156	69
SX122	68
SX125	68
SX137	68
SX138	69



42



60



68



71



72



74



76



78



80



82



83



84



86



91



92



100



Wij danken iedereen die meegewerkt heeft aan de realisatie van deze brochure. Nous remercions tout le monde qui a collaboré à la réalisation de ce catalogue. We would like to thank everybody who helped with the creation of this brochure. Wir danken allen Personen, die an der Herstellung dieser Broschüre mitgewirkt haben. Agradecemos la colaboración a todas las personas que han participado en la realización de este catálogo.

Projects: 'Coca-Cola Loge' by Pinkeye (BE) - www.pinkeye.be
 Hotel Majestic (ES) - www.hotelmajestic.es
 Restaurante Boca Grande (ES)
www.metiendovivendum.com

Eichholtz A'dam (NL) - www.eichholtz.com
 Hotel the Black Antwerp (BE) - www.hoteltheblack.be
 Restaurante La Rambla by Ana Generó (ES) - www.larambla.biz
www.houseofporters.com

Balo 'Living in Style' (BE)- www.balolivinginstyle.be
 Private residence, Ponseele (BE) - www.patrickponseele.be
 Hotel Alma (ES) - www.almabarcelona.com

This catalogue and the designs embodied within are protected by copyright law and international treaties. Unauthorized reproduction of the catalogue or any portion of it or reproduction of any of the designs embodied therein may result in severe civil and criminal penalties and will be prosecuted to the maximum.

★ **ORAC HEADQUARTERS**

NV ORAC SA

BIEKORFSTRAAT 32,
8400 OSTEND, BELGIUM
T +32 (0)59 80 32 52
F +32 (0)59 80 28 10
INFO@ORACDECOR.COM

★ **ORAC FRANCE**

T 0800-900 358
F +32 (0)59 80 28 10
FRANCE@ORACDECOR.COM

★ **ORAC (UK) Ltd.**

ELMBRIDGE ROAD UNIT 5
HEWITTS ESTATE
CRANLEIGH, SURREY
GU6 8LW
UNITED KINGDOM
T +44 (0)1483 271 211
F +44 (0)1483 278 317
UK@ORACDECOR.COM

★ **ORAC SLOVAKIA S.R.O.**

KPT. NALEPKU 6
SK-08271 LIPANY
T +421 (0)514-891 581
F +421 (0)514-573 595
SLOVAKIA@ORACDECOR.COM

★ **ORAC NEDERLAND**

T 0800-022 2125
F 0800-022 2138
NEDERLAND@ORACDECOR.COM

★ **ORAC DEUTSCHLAND**

T 0800-181 3694
F +32 (0)59 34 05 24
DEUTSCHLAND@ORACDECOR.COM

★ **ORAC SPAIN**

T 0900 99 32 89
F +32 (0)59 80 28 10
SPAIN@ORACDECOR.COM